

TAVIC[®]

**LUXURY
WARDEROBES &
PARTITION
SYSTEMS**





ABOUT US

The World of TAITON provides you with the Largest and most Comprehensive product range which has been intelligently crafted to suit the modern Hi-tech commercial and residential establishments. We have a rich tradition of manufacturing and distributing high Quality Architectural Hardware which meets and exceeds expectations.

The tradition has inspired us to foray into diverse fields of premium & exclusive products to decorate your interior spaces. Our diversified product portfolio is strategically divided into 9 verticals. In the current dynamic world infrastructural development is witnessing the rapid advancement, hence, there is a requirement to continuously innovate the products utilizing latest technologies to offer solutions that match perfectly to the need of modern customers.

Being a Quality conscious firm, we never compromise with Quality of our products. For that, we conduct an elaborate research on the materials to be used and the prevailing market trends. We ensure that our products undergo strict quality checks on various parameters like durability, finishing and robustness before they are delivered to our customers.

TAITON will keep challenging itself in the new era, dedicating to supply more beautiful and high quality products for a better living. We offer prompt & courteous delivery of our products and efficient customer service.

Exceptional functional & technical expertise coupled with extensive industry knowledge makes TAITON the ideal choice for implementation of your desires into reality.

INDEX

TELESCOPIC SLIDING SYSTEMS	01-09
SYNCHRO SLIDING SYSTEMS	10-14
SLIDING FOLDING SYSTEM	15-16
COLUMN SYSTEM	17-18
CUBE SHELF SYSTEM	19-20
GLOWING GLASS LAMP SYSTEM	21-22
SLEEK BEVELED FRAMED GLASS DOOR	23-24
WARDROBE SLIDING SYSTEMS	25-29
WARDROBE HYDRAULIC HINGES	30-31
WARDROBE AIR HINGES	32-33
WARDROBE EDGE HANDLES	34-35
DRAWER HEDGE HANDLES	36-37
INVISIBLE SLIDING SYSTEMS	38-39
AUTOMATIC SLIM FRAMED SLIDING SYSTEMS	40-42
SLIM FRAMED SWING DOOR	43-44
MANUAL WOODEN SLIDING SYSTEMS	45-46
ACCESSARIES	47



1+0 TELESCOPIC SLIDING SYSTEM



SYSTEM TYPE

1+0 TELESCOPIC

MAX WIDTH & HEIGHT

950MM (W) / 3000MM (H)

MANUAL KIT WEIGHT CAPACITY

60 / 80 KG'S

PROFILE FINISH

NORMAL - BLACK / B-GOLD / R-GOLD
HD - BLACK / GRAY / CHAMP / BRUSH GOLD / ROSE GOLD

GLASS LIMITATION

5MM TO 10MM

SECURITY SYSTEM

HANDLE WITH LATCH / LOCK

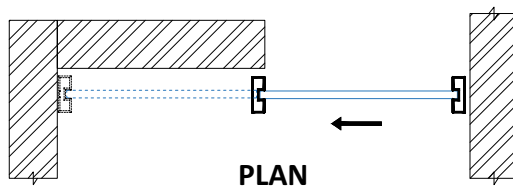
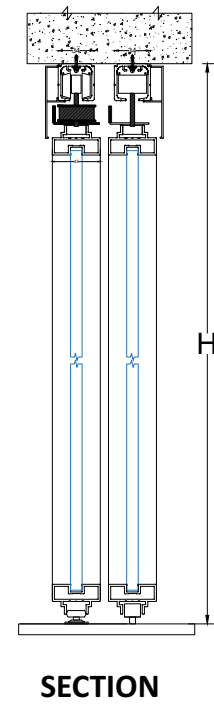
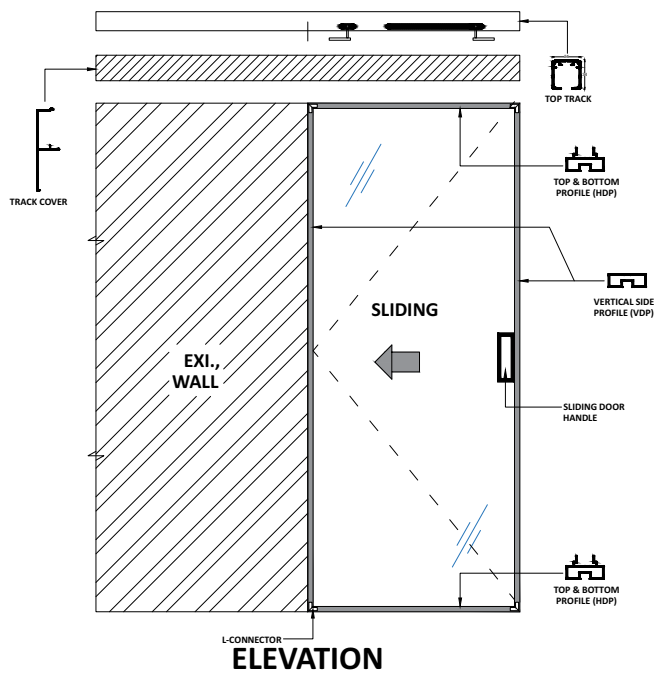

1+1 TELESCOPIC SLIDING SYSTEM



SYSTEM TYPE

1+1 TELESCOPIC

MAX WIDTH & HEIGHT

950MM (W) / 3000MM (H)

MANUAL KIT WEIGHT CAPACITY

60 / 80 KG'S

PROFILE FINISH

NORMAL - BLACK / B-GOLD / R-GOLD

HD - BLACK / GRAY / CHAMP / BRUSH GOLD / ROSE GOLD

GLASS LIMITATION

5MM TO 10MM

SECURITY SYSTEM

HANDLE WITH LATCH / LOCK

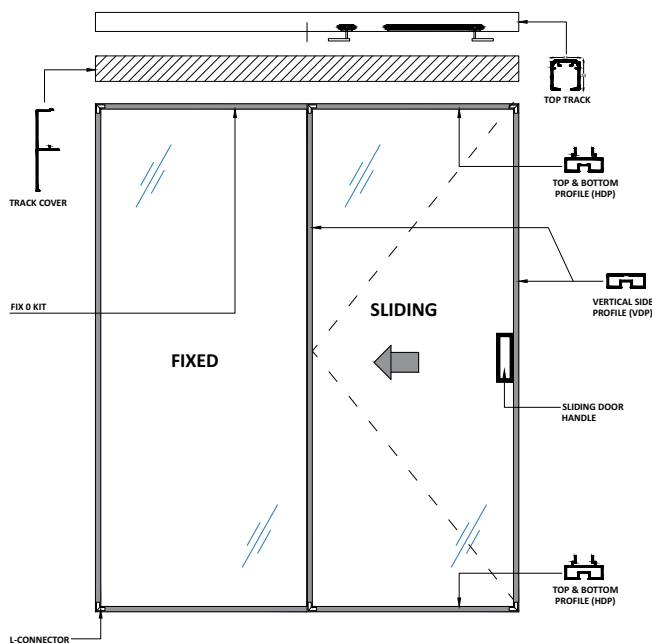

ELEVATION

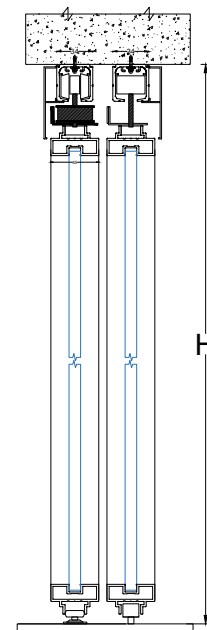

SECTION

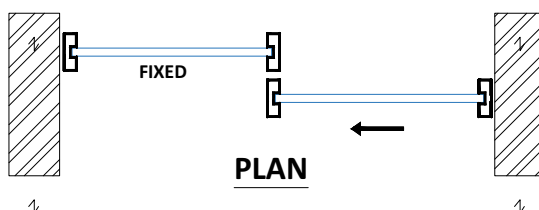

PLAN

2+0 TELESCOPIC SLIDING SYSTEM



SYSTEM TYPE

2+0 TELESCOPIC

MAX WIDTH & HEIGHT

950MM (W) / 3000MM (H)

MANUAL KIT WEIGHT CAPACITY

60 / 80 KG'S

PROFILE FINISH

NORMAL - BLACK / B-GOLD / R-GOLD

HD - BLACK / GRAY / CHAMP / BRUSH GOLD / ROSE GOLD

GLASS LIMITATION

5MM TO 10MM

SECURITY SYSTEM

HANDLE WITH LATCH / LOCK

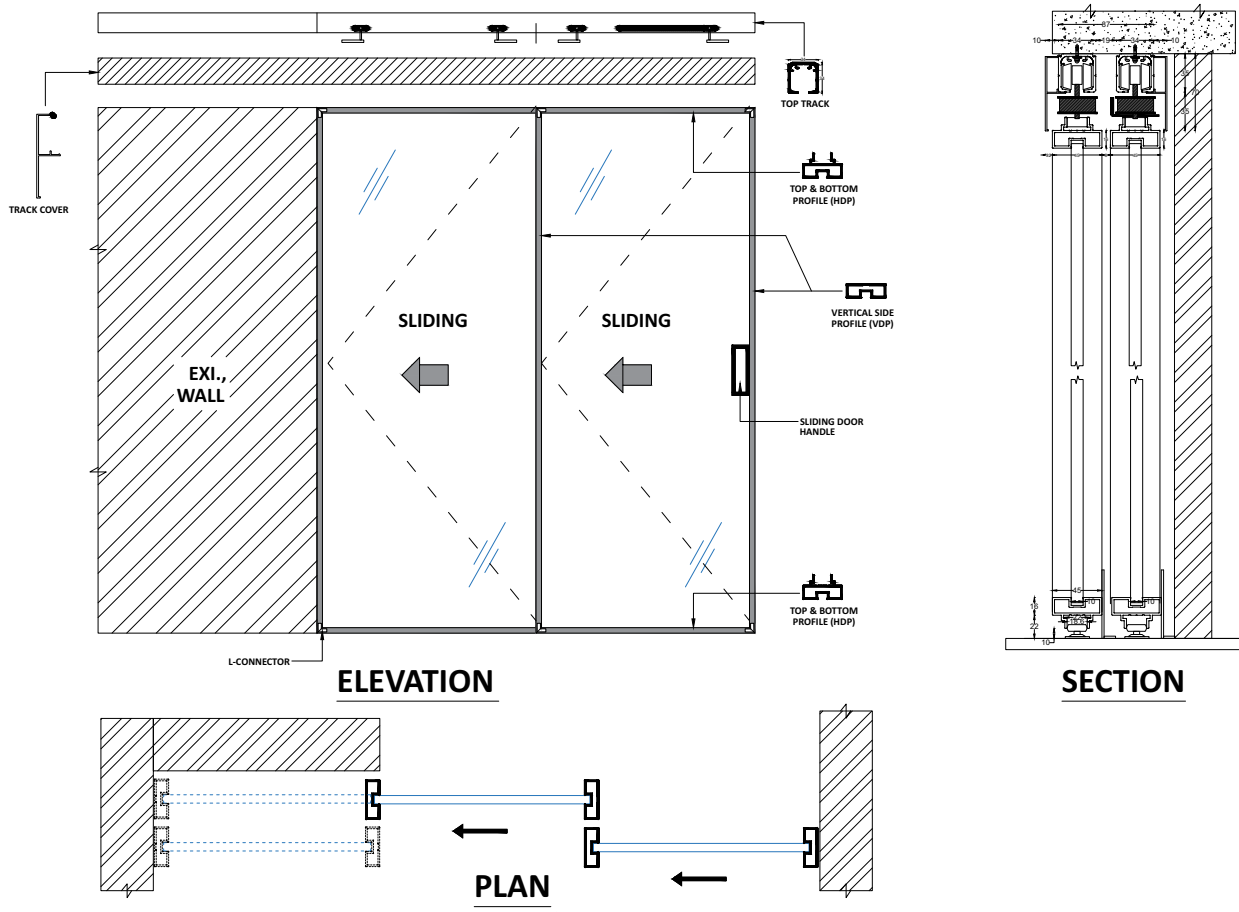

2+1 TELESCOPIC SLIDING SYSTEM



SYSTEM TYPE

2+1 TELESCOPIC

MAX WIDTH & HEIGHT

950MM (W) / 3000MM (H)

MANUAL KIT WEIGHT CAPACITY

60 / 80 KG'S

PROFILE FINISH

NORMAL - BLACK / B-GOLD / R-GOLD

HD - BLACK / GRAY / CHAMP / BRUSH GOLD / ROSE GOLD

GLASS LIMITATION

5MM TO 10MM

SECURITY SYSTEM

HANDLE WITH LATCH / LOCK

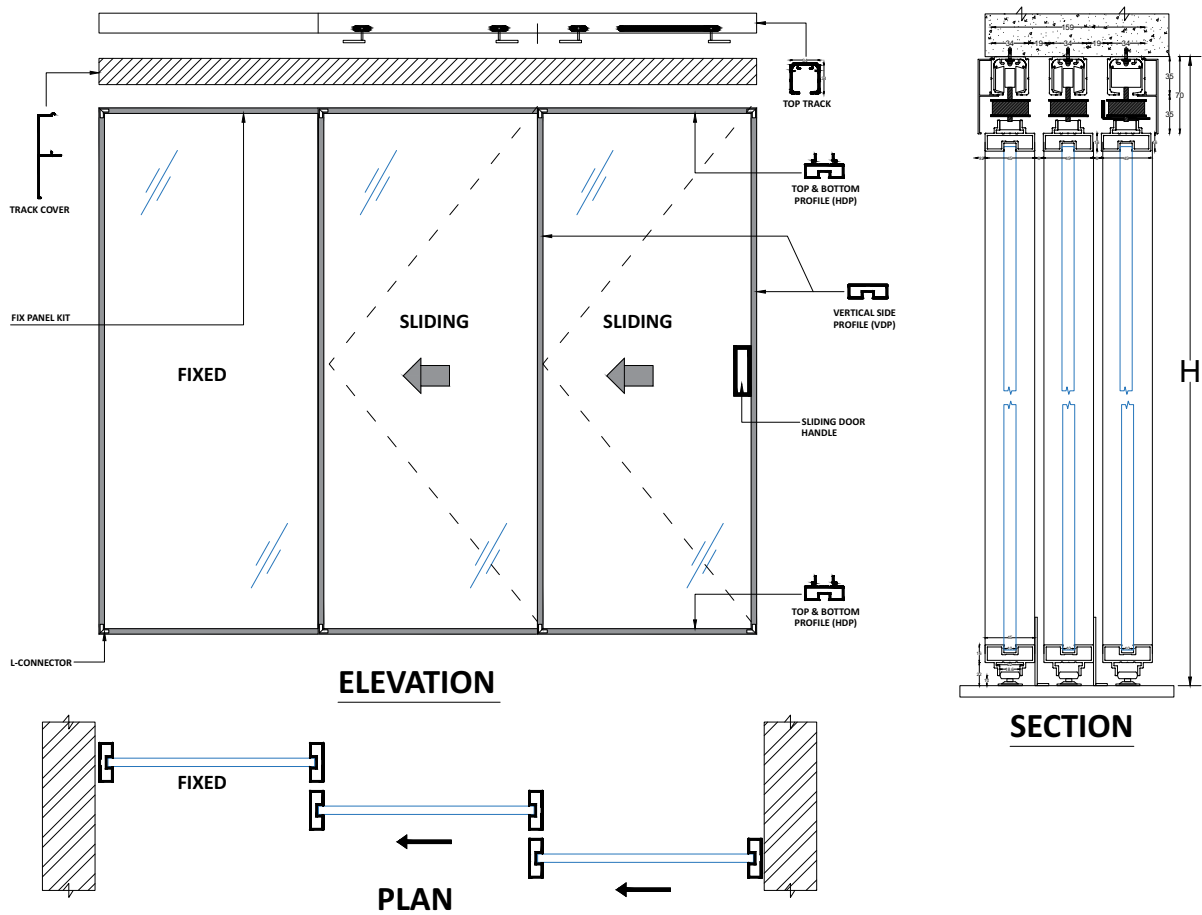

3+0 TELESCOPIC SLIDING SYSTEM



SYSTEM TYPE

3+0 TELESCOPIC

MAX WIDTH & HEIGHT

950MM (W) / 3000MM (H)

MANUAL KIT WEIGHT CAPACITY

60 / 80 KG'S

PROFILE FINISH

NORMAL - BLACK / B-GOLD / R-GOLD

HD - BLACK / GRAY / CHAMP / BRUSH GOLD / ROSE GOLD

GLASS LIMITATION

5MM TO 10MM

SECURITY SYSTEM

HANDLE WITH LATCH / LOCK

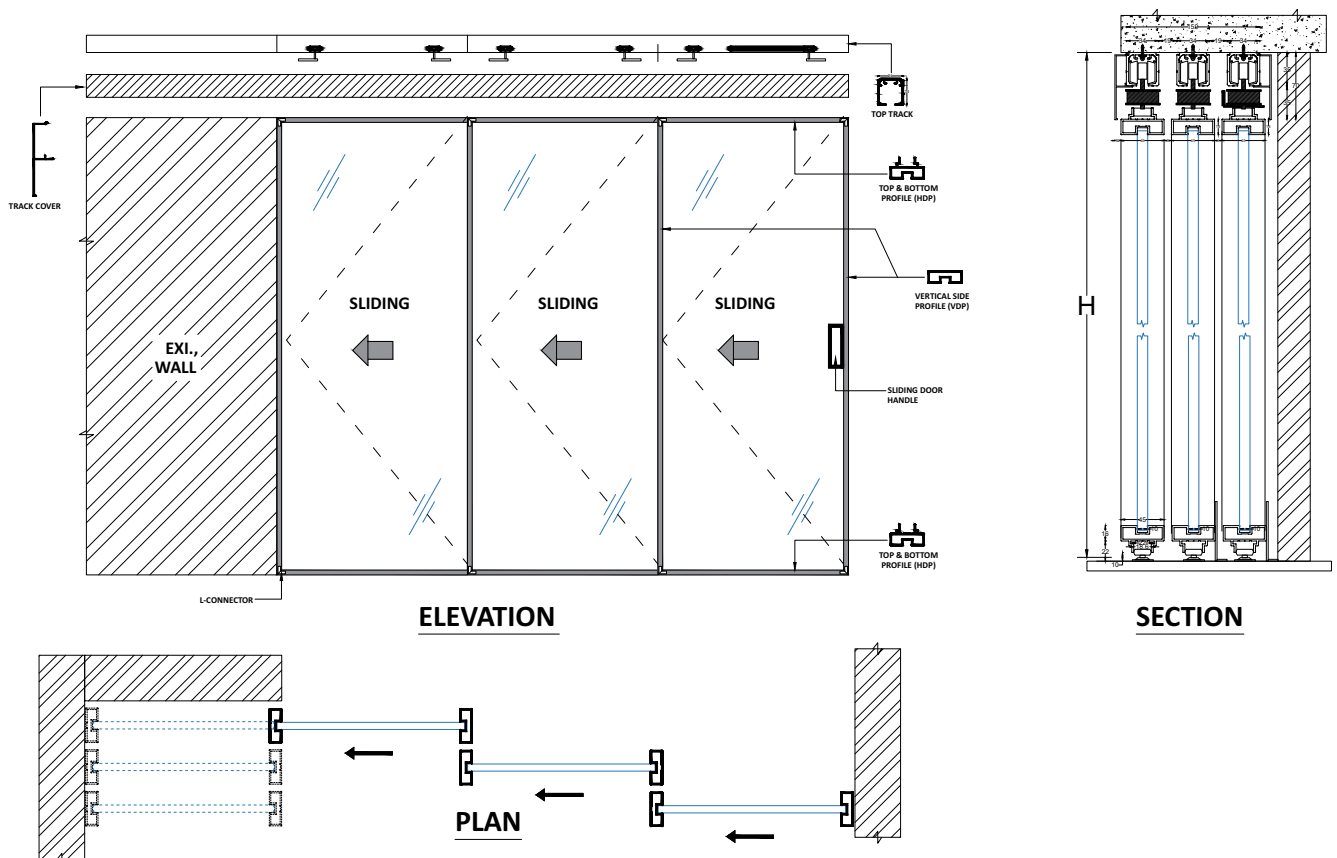

3+1 TELESCOPIC SLIDING SYSTEM



SYSTEM TYPE

3+1 TELESCOPIC

MAX WIDTH & HEIGHT

950MM (W) / 3000MM (H)

MANUAL KIT WEIGHT CAPACITY

60 / 80 KG'S

PROFILE FINISH

NORMAL - BLACK / B-GOLD / R-GOLD
HD - BLACK / GRAY / CHAMP / BRUSH GOLD / ROSE GOLD

GLASS LIMITATION

5MM TO 10MM

SECURITY SYSTEM

HANDLE WITH LATCH / LOCK

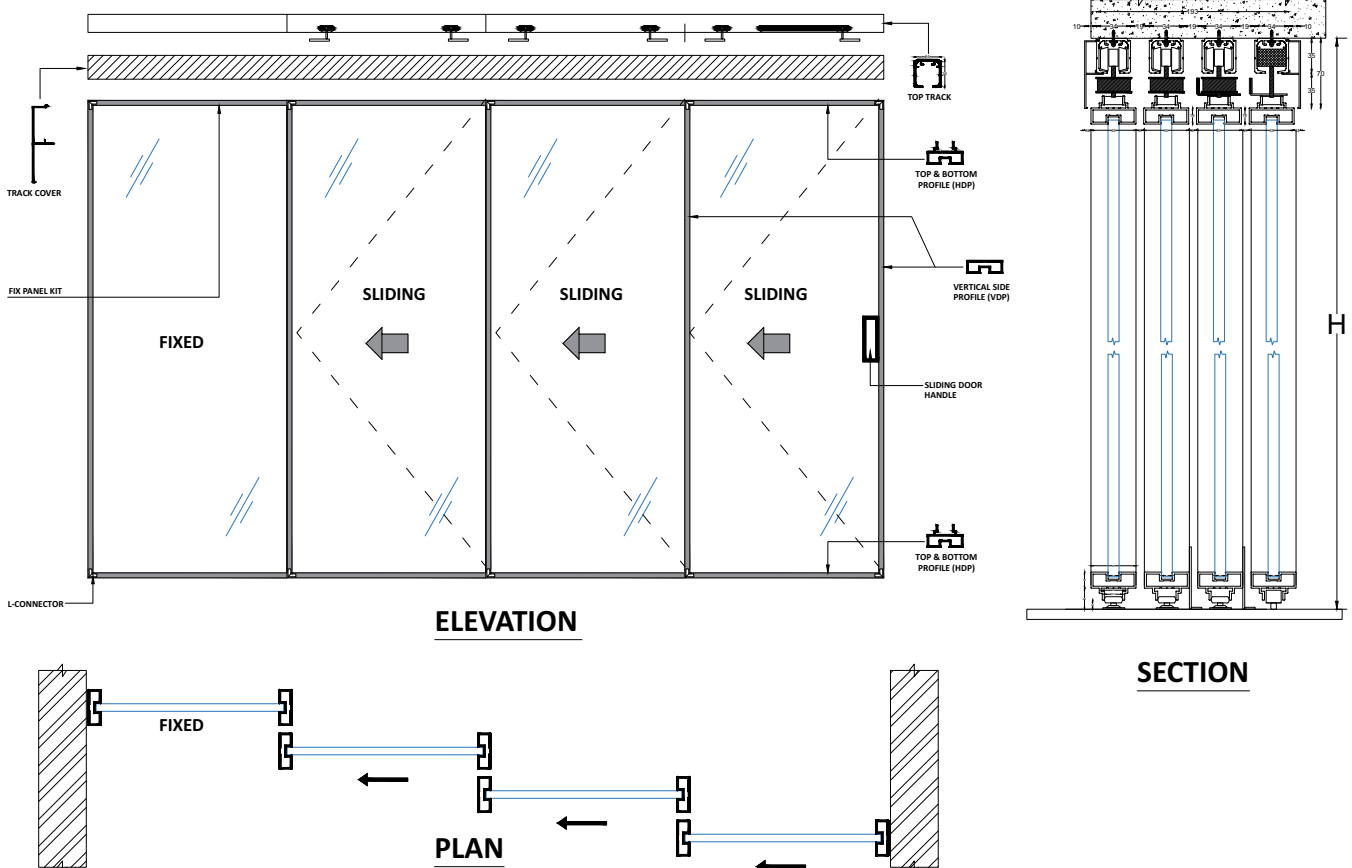

4+0 (HD) TELESCOPIC SLIDING SYSTEM



SYSTEM TYPE

4+0 (HD) TELESCOPIC

MAX WIDTH & HEIGHT

950MM (W) / 3000MM (H)

MANUAL KIT WEIGHT CAPACITY

60 / 80 KG'S

PROFILE FINISH

NORMAL - BLACK / B-GOLD / R-GOLD

HD - BLACK / GRAY / CHAMP / BRUSH GOLD / ROSE GOLD

GLASS LIMITATION

5MM TO 10MM

SECURITY SYSTEM

HANDLE WITH LATCH / LOCK

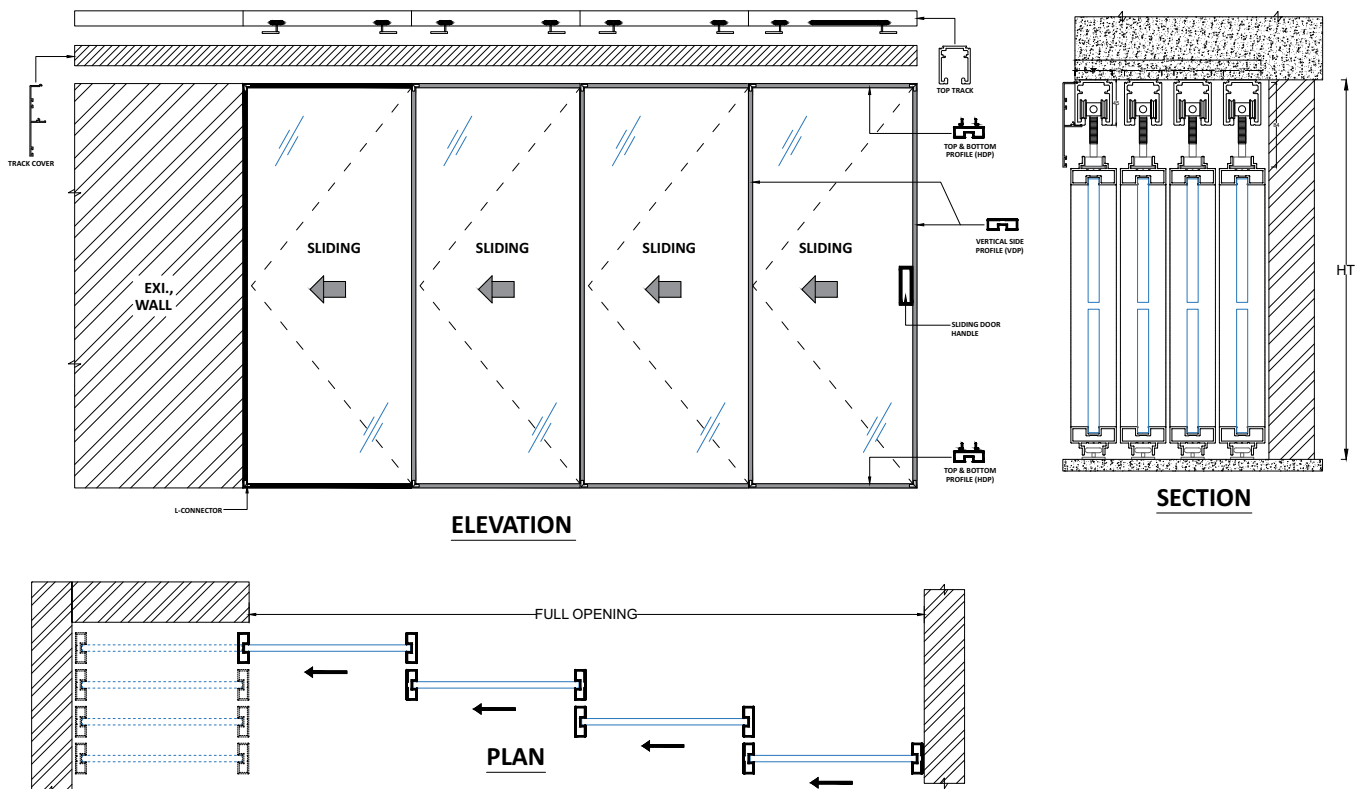

4+1 (HD) TELESCOPIC SLIDING SYSTEM

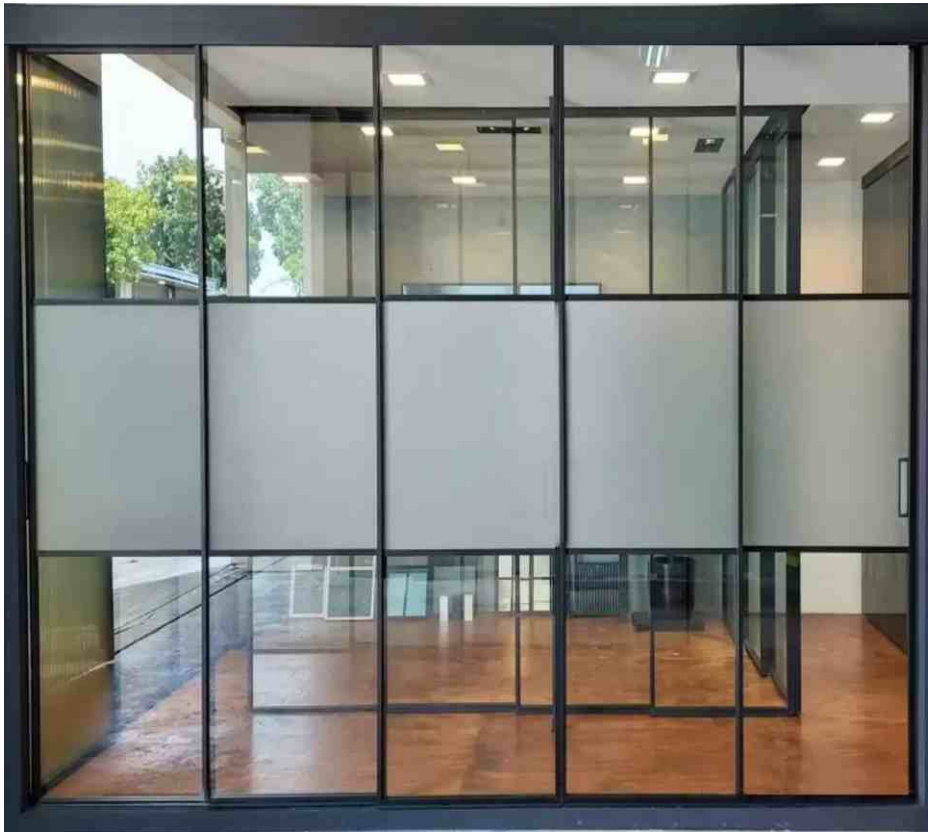

SYSTEM TYPE

4+1 (HD) TELESCOPIC

MAX WIDTH & HEIGHT

950MM (W) / 3000MM (H)

MANUAL KIT WEIGHT CAPACITY

60 / 80 KG'S

PROFILE FINISH

NORMAL - BLACK / B-GOLD / R-GOLD

HD - BLACK / GRAY / CHAMP / BRUSH GOLD / ROSE GOLD

GLASS LIMITATION

5MM TO 10MM

SECURITY SYSTEM

HANDLE WITH LATCH / LOCK

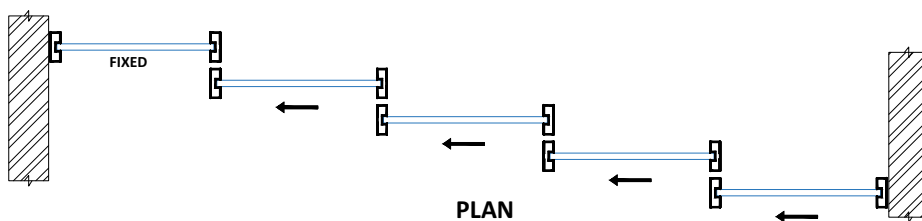
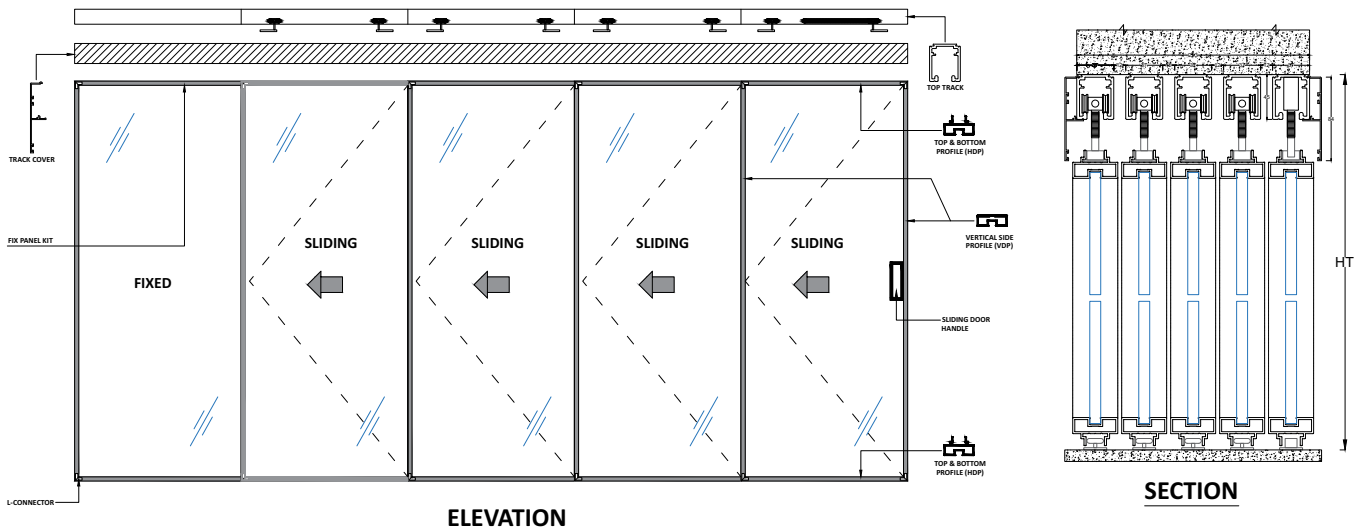



2+0 (OPP) SYNCHRO SLIDING SYSTEM



SYSTEM TYPE

2+0 (OPP) SYNCHRO

MAX WIDTH & HEIGHT

950MM (W) / 3000MM (H)

MANUAL KIT WEIGHT CAPACITY

60 / 80 KG'S

PROFILE FINISH

NORMAL - BLACK / B-GOLD / R-GOLD
HD - BLACK / GRAY / CHAMP / BRUSH GOLD / ROSE GOLD

GLASS LIMITATION

5MM TO 10MM

SECURITY SYSTEM

HANDLE WITH LATCH / LOCK

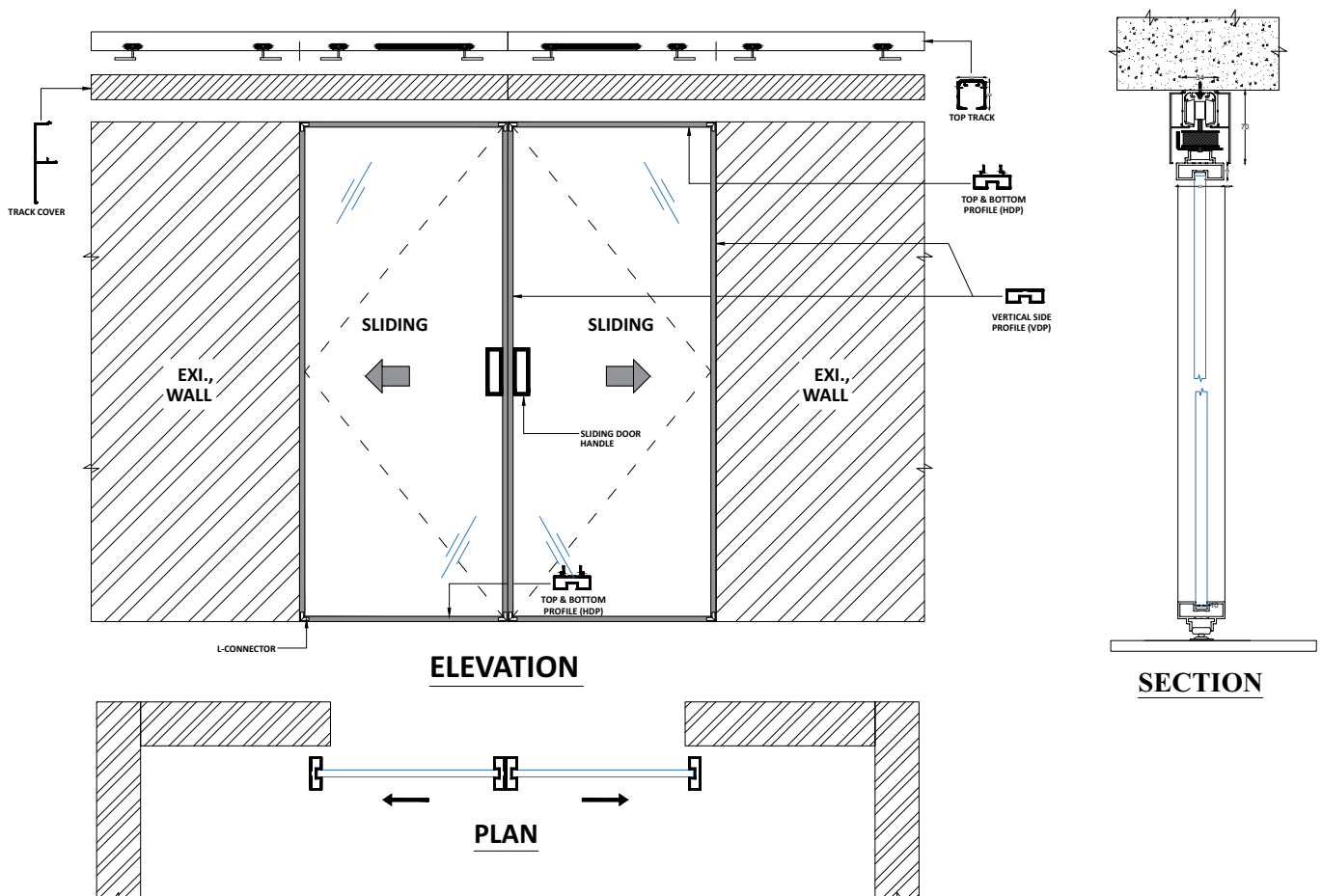

2+2 (OPP) SYNCHRO SLIDING SYSTEM



SYSTEM TYPE

2+2 (OPP) SYNCHRO

MAX WIDTH & HEIGHT

950MM (W) / 3000MM (H)

MANUAL KIT WEIGHT CAPACITY

60 / 80 KG'S

PROFILE FINISH

NORMAL - BLACK / B-GOLD
/ R-GOLD

HD - BLACK / GRAY / CHAMP
/ BRUSH GOLD / ROSE GOLD

GLASS LIMITATION

5MM TO 10MM

SECURITY SYSTEM

HANDLE WITH LATCH / LOCK

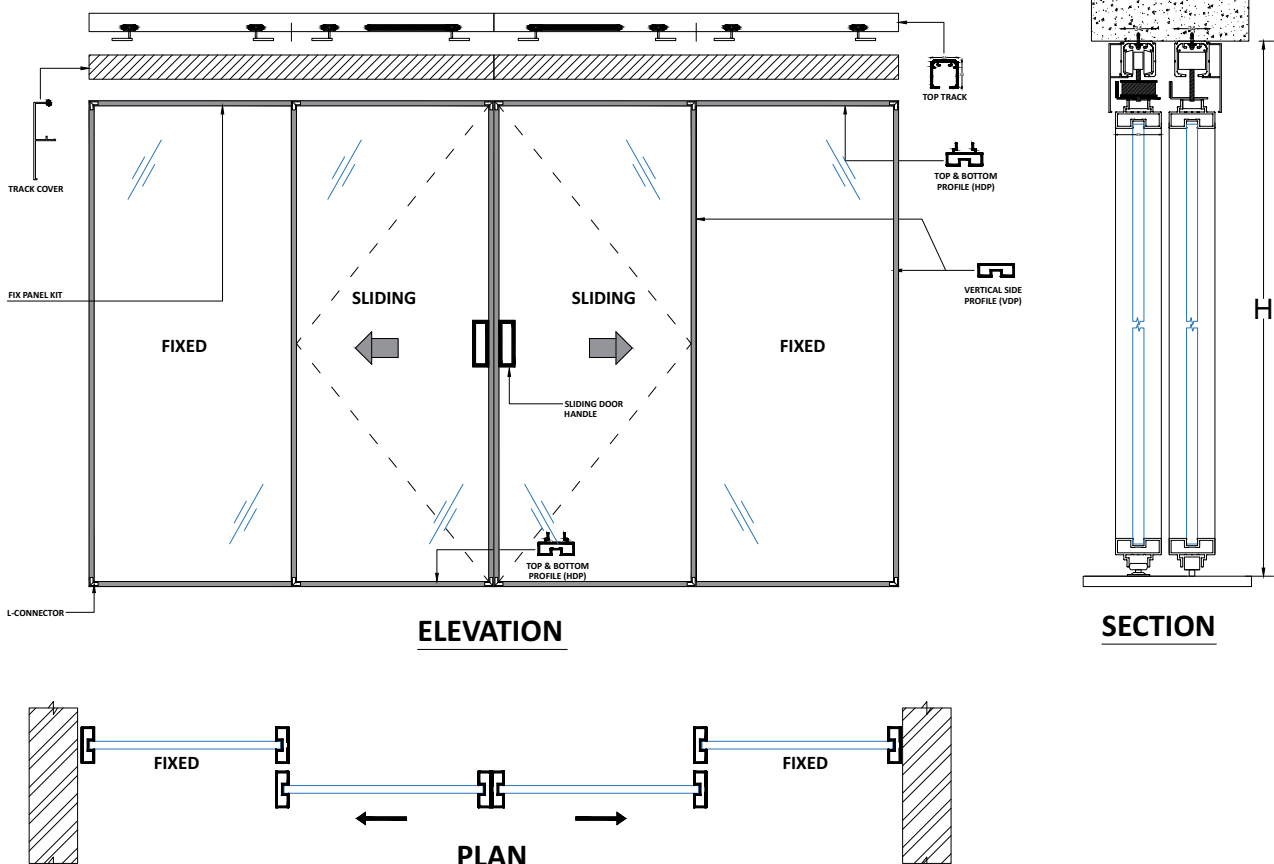

4+0 OPP (HD) SYNCHRONY SLIDING SYSTEM



SYSTEM TYPE

4+0 OPP (HD) SYNCHRONY

MAX WIDTH & HEIGHT

950MM (W) / 3000MM (H)

MANUAL KIT WEIGHT CAPACITY

60 / 80 KG'S

PROFILE FINISH

NORMAL - BLACK / B-GOLD / R-GOLD

HD - BLACK / GRAY / CHAMP / BRUSH GOLD / ROSE GOLD

GLASS LIMITATION

5MM TO 10MM

SECURITY SYSTEM

HANDLE WITH LATCH / LOCK

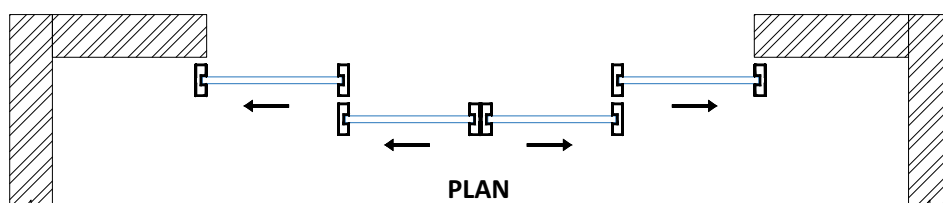
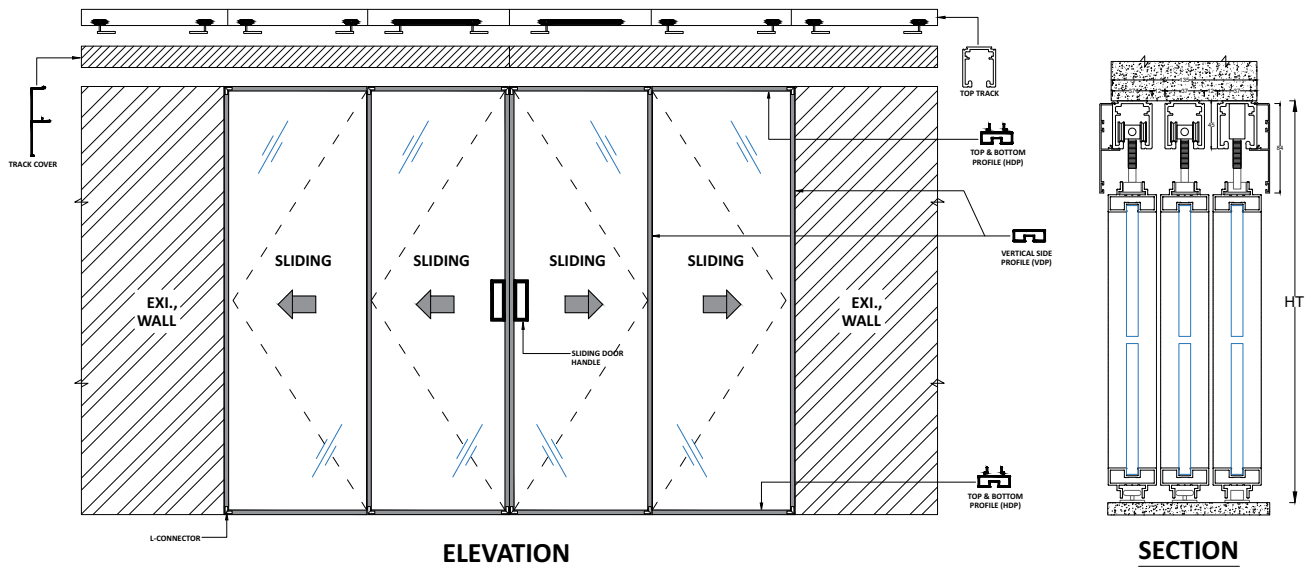

4+2 (HD) SYNCHRONY SLIDING SYSTEM



SYSTEM TYPE

4+2 OPP (HD) SYNCHRONY

MAX WIDTH & HEIGHT

950MM (W) / 3000MM (H)

MANUAL KIT WEIGHT CAPACITY

60 / 80 KG'S

PROFILE FINISH

NORMAL - BLACK / B-GOLD / R-GOLD

HD - BLACK / GRAY / CHAMP / BRUSH GOLD / ROSE GOLD

GLASS LIMITATION

5MM TO 10MM

SECURITY SYSTEM

HANDLE WITH LATCH / LOCK

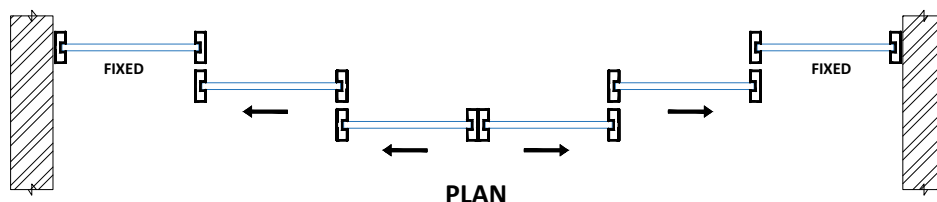
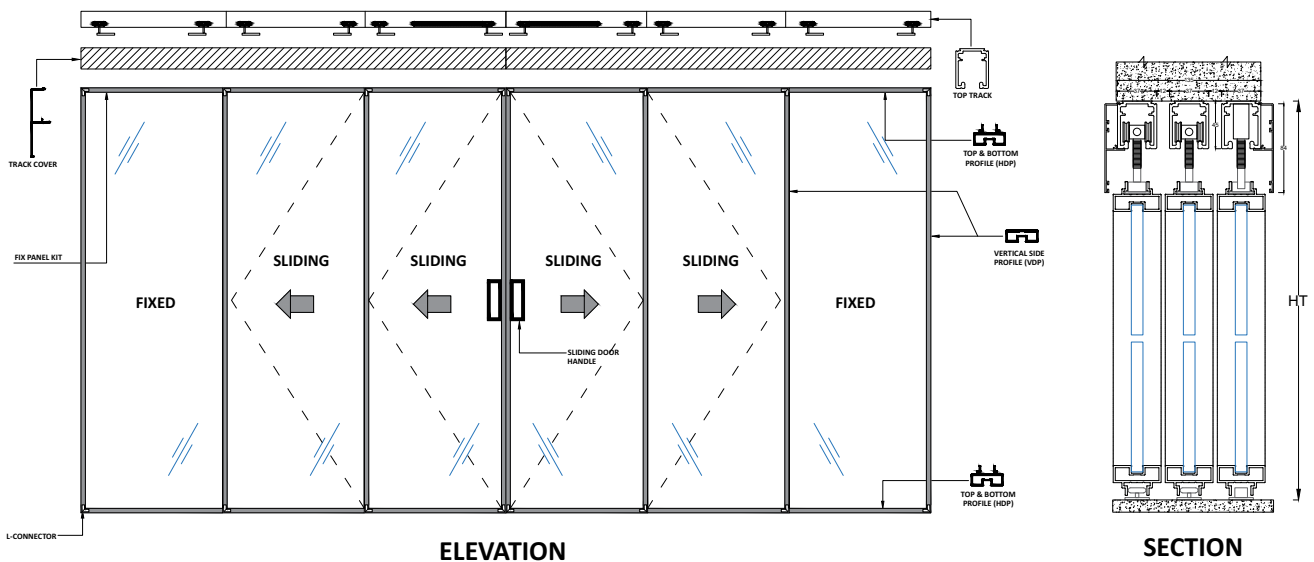



SLIDING FOLDING SYSTEM

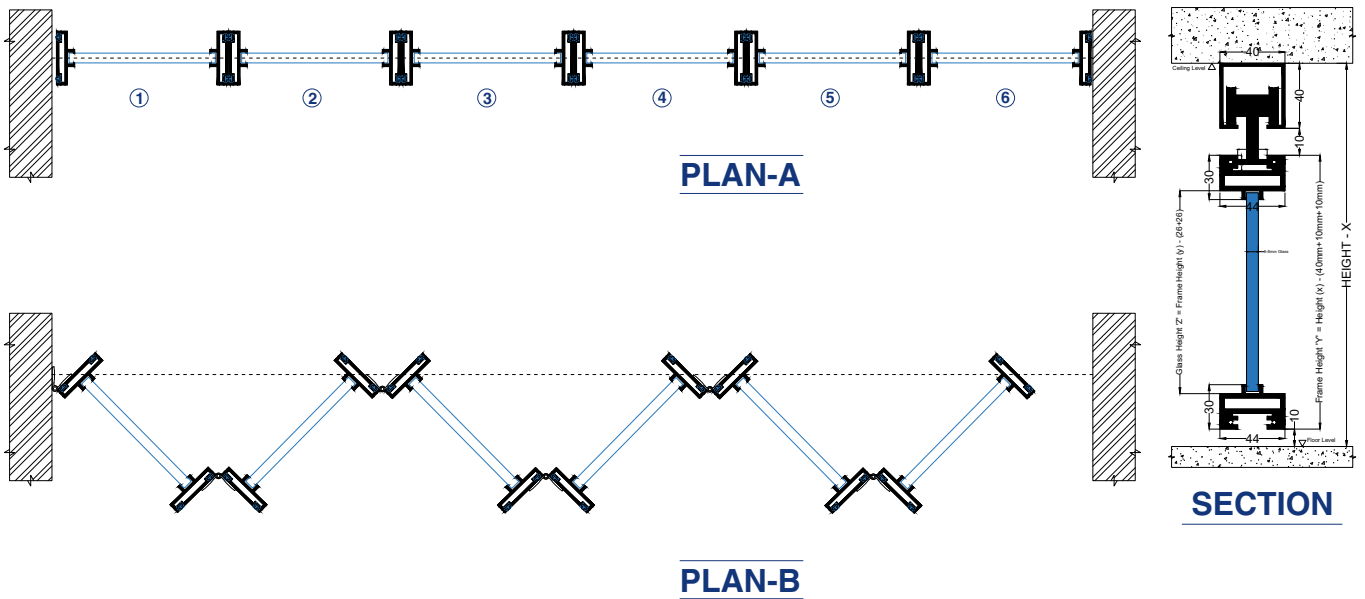

<p>TAV-SFS-V Vertical Profile</p>	<p>TAV-SFS-H Horizontal Profile</p>	<p>TAV-SFS-TT Top Track</p>	<p>TAV-SFS-PIVOT Starting panel top and bottom pivots</p>	<p>TAV-SFS-HINGE Top and Bottom hinge where door folds</p>
<p>TAV-SFS-LD Lock & Rod (it will be used where 2 doors folded)</p>	<p>TAV-SFS-WB Hanging wheel with braket</p>	<p>TAV-SFS-V-strip1 Anti-collision strip for vertical profile</p>	<p>TAV-SFS-EC Profile corner end caps</p>	<p>TAV-SFS-TT(strip) Seal strip for Top track</p>
<p>TAV-SFS-PVC-strip seal strip with hole for glass 6mm or 8mm 2.5 MTR/PC</p>	<p>TAV-SFS-V-strip2 plastic strip for vertical profile (decorative seal strip) 2.5 MTR/PC</p>	<p>TAV-SFS-Magnet Anti-collision magnet (set means 2 pcs)</p>	<p>TAV-SFS-DB Decorative bar</p>	



COLUMN SYSTEM

Features:-

Material : Aluminum Alloy
 Color : Brown, Grey
 Glass Thickness : 5 mm

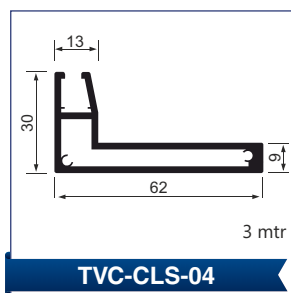
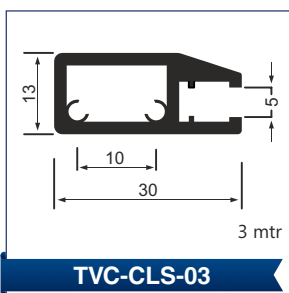
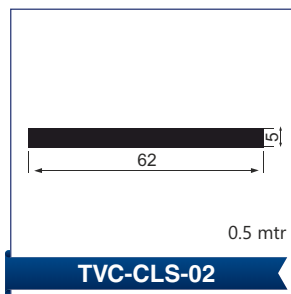
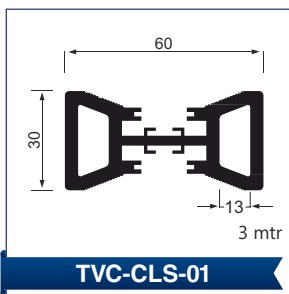
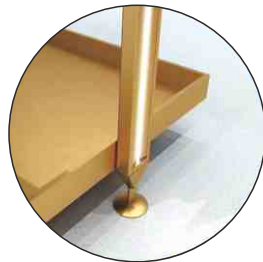



Cube Shelf System



TVC-CSS- CORNER

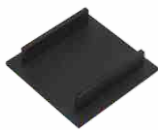

TVC-CSS- CAP



TVC-CSS- LEG

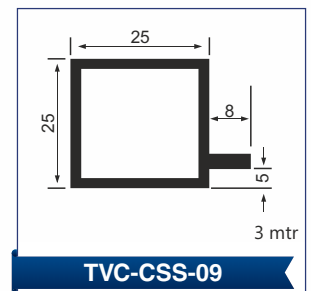
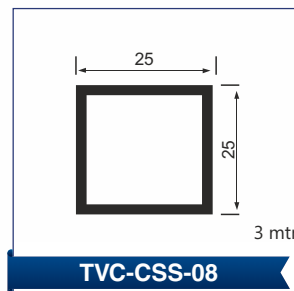

CUBE SHELF SYSTEM

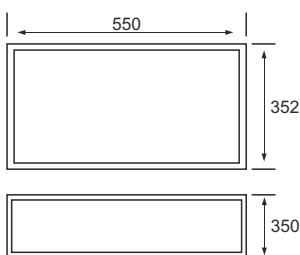

On-Wall Combined Rack
 Material:- Aluminum Alloy
 Finish:- Black Matte, Brush Gold
 Size:- 550x352x350mm

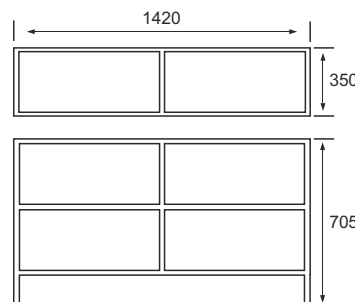

Island Base Rack
 Material:- Aluminum Alloy
 Finish:- Black Matte, Brush Gold
 Size:- 1420x705x350mm

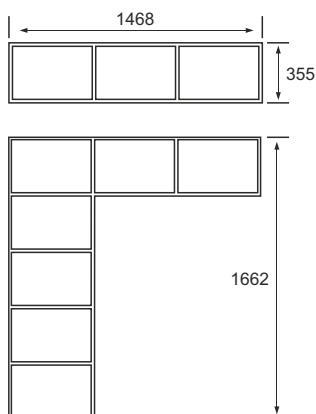

L-Shaped on-wall Combined Rack
 Material:- Aluminum Alloy
 Finish:- Black Matte, Brush Gold
 Size:- 1662x1468x355mm

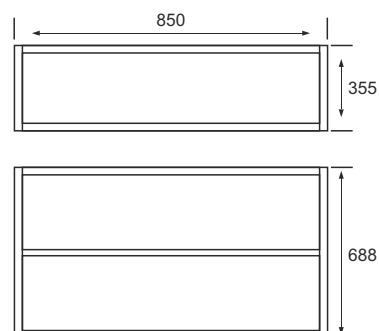

Two layer Aluminum Combined Rack
 Material:- Aluminum Alloy
 Finish:- Black Matte, Brush Gold
 Size:- 850x355x688mm



GLOWING GLASS LAMP SYSTEM

Aluminum-Frame Laminate

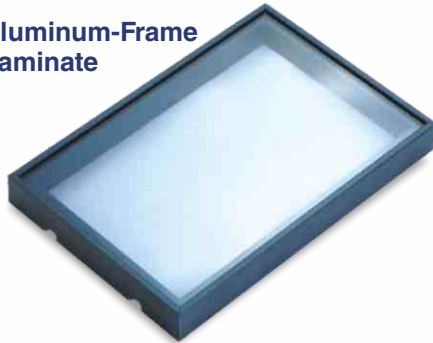

45°

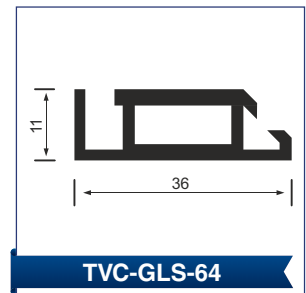
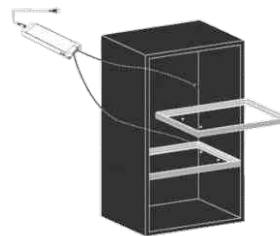

PRODUCT FEATURES

- LED Aluminum Alloy Framed Glass Laminate to Replace Common Wood Laminate to make the Cabinet Inside Brighter, More Trendy and Elegant in matching. Used in Wardrobe, Cupboard, Wine Cabinet (Can match with Clear Glass, Black Glass or Brown Glass. Size: Ultra Clear Glass 36mm High, 5mm Thick
- Color Temperature & Light Source:- Yellow light
- WW: 3000K/Warm light NW: 4000K/White light CW:6000K
- Switch Mode:- Human Body Sensing, Door Stopper Switch, Hand-scan Switch, Touch Switch

Light Emission Angle

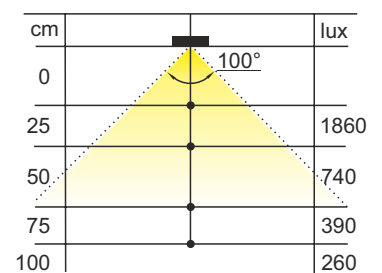

ORDERING INFORMATION

Name	Size	Voltage	CCT	Switch	Power	Option Color
	mm	VDC	K			
Glowing Glass Lamp System	3mtr	12	3000 4000 6000	External Switch or Induction Sensor	Constant Voltage Driver	Brush Gold & Black Matt



SLEEK BEVELED FRAMED GLASS DOOR



Features:

Material: Aluminium alloy

Color: Black & Grey

Glass thickness: 5mm tempered glass

Applicable Cabinets: Cupboard/Bookcase, Vestibule/Wine Cabine Wardrobe/Tv Cabinet

Special-purpose equipment specially made

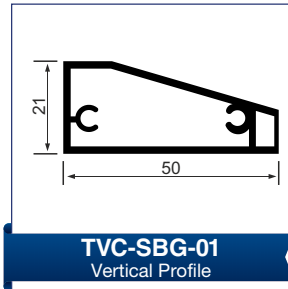

TVC-SBG-01
Vertical Profile

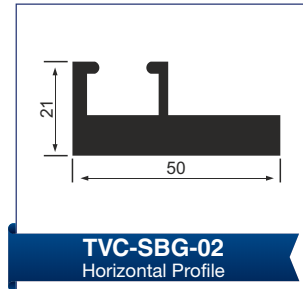

TVC-SBG-02
Horizontal Profile



TVC-SBG-01-H
Handle



TVC-SBG-CH
Concealed Hinge

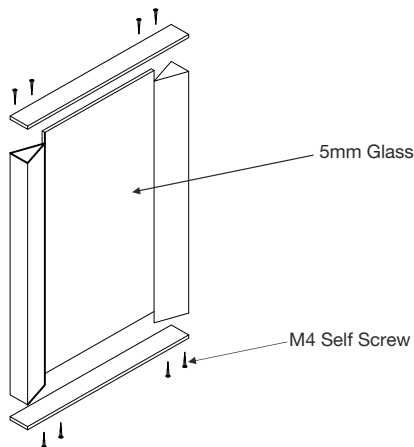



CARNIVAL WARDROBE SLIDING SYSTEMS

Features:-

- + Door Weight Capacity:- 60kg Max
- + Two Way Soft Close Mechanism
- + Available with lock option
- + Can use 4mm glass or 10mm decorative panel
- + Profile length available: 3000mm

Finish Available:-

- + Black Matte, Champagne, Grey Matt & Rose Gold

2 DOOR WARDROBE SLIDING

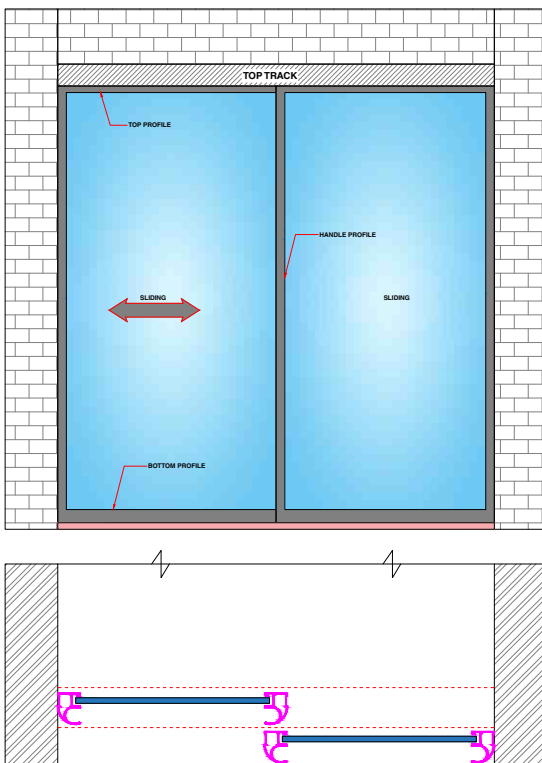

3 DOOR WARDROBE SLIDING

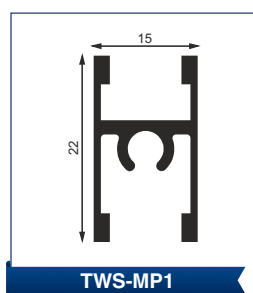
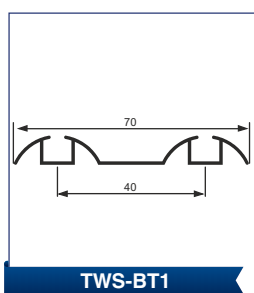
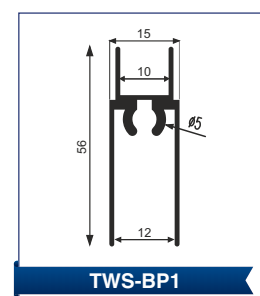
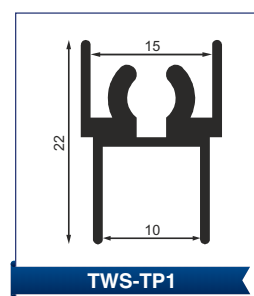
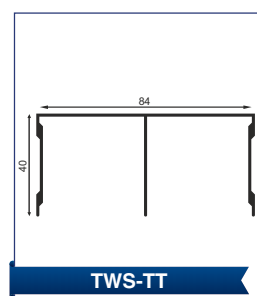
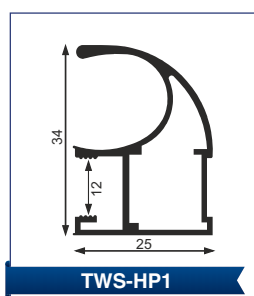
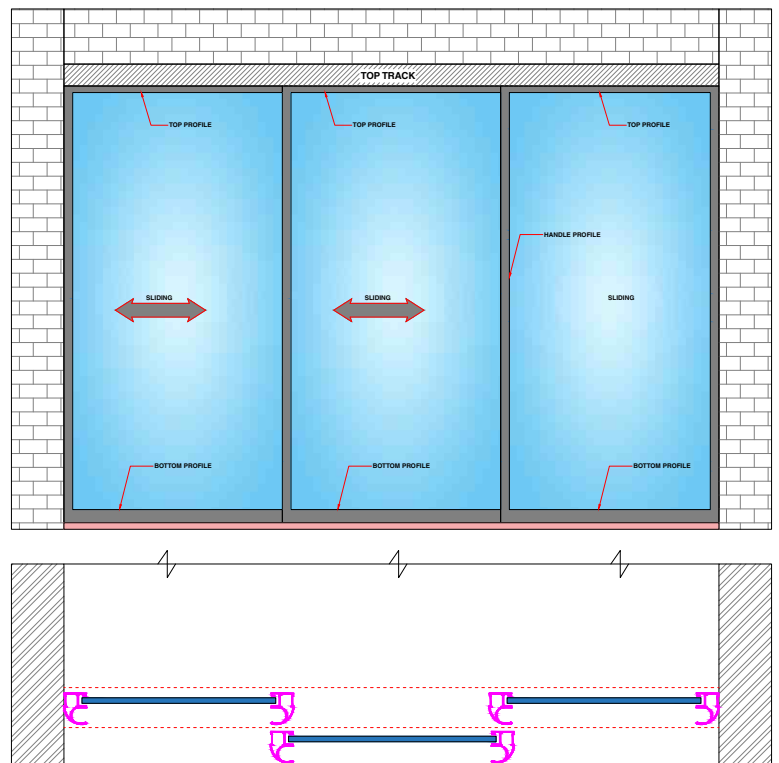

COSTA WARDROBE SLIDING SYSTEMS

Features:-

- + Door Weight Capacity:- 60kg Max
- + Two Way Soft Close Mechanism
- + Available with lock option
- + Can use 4mm glass or 10mm decorative panel
- + Profile length available: 3000mm

Finish Available:-

- + Black Matte, Champagne & Grey Matt

2 DOOR WARDROBE SLIDING

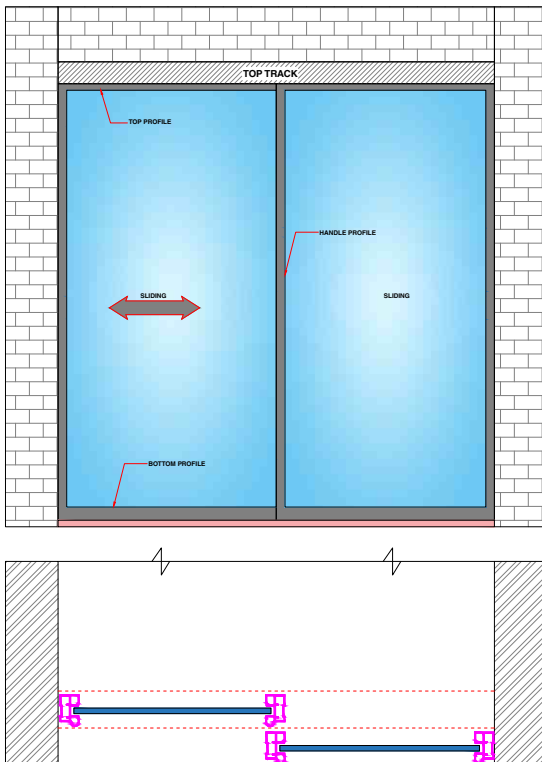

3 DOOR WARDROBE SLIDING

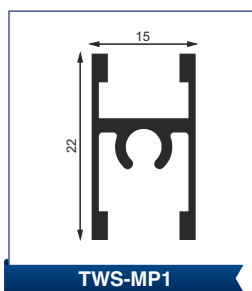
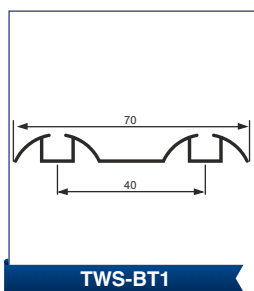
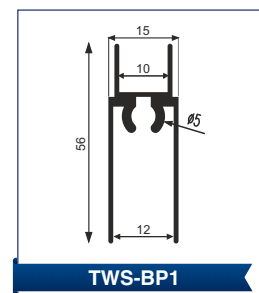
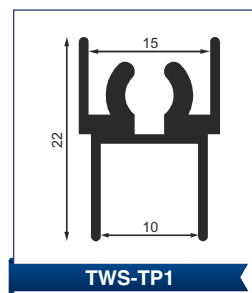
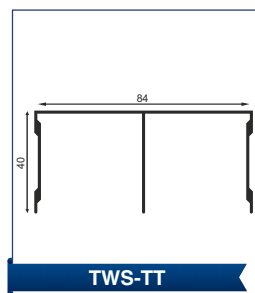
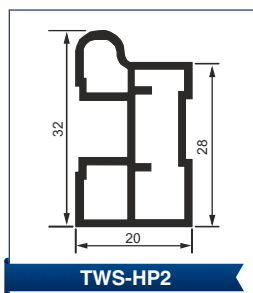
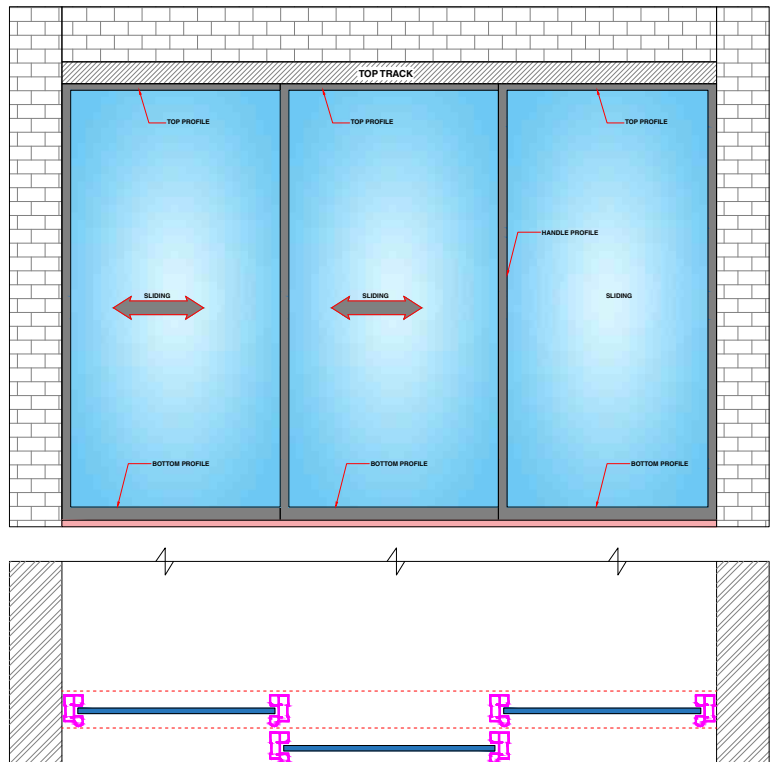

CELEBRITY WARDROBE SLIDING SYSTEMS

Features:-

- + Door Weight Capacity:- 60kg Max
- + Two Way Soft Close Mechanism
- + Available with lock option
- + Can use 4mm glass or 10mm decorative panel
- + Profile length available: 3000mm

Finish Available:-

- + Black Matte & Champagne

2 DOOR WARDROBE SLIDING

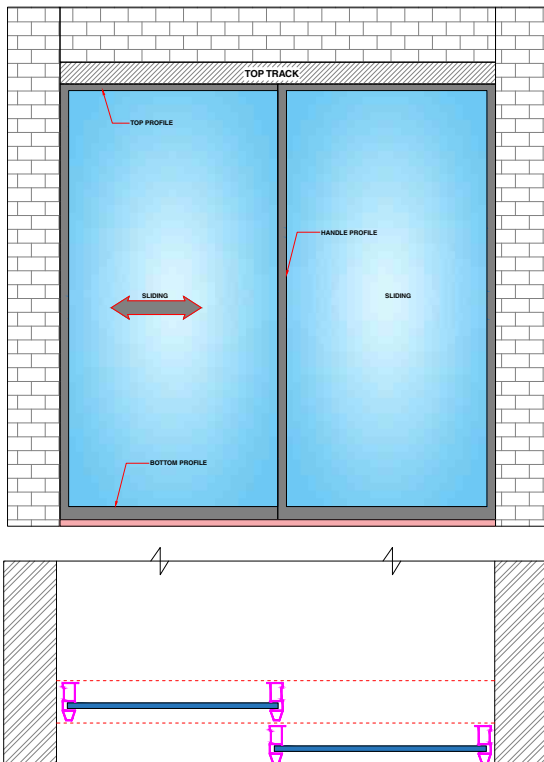

3 DOOR WARDROBE SLIDING

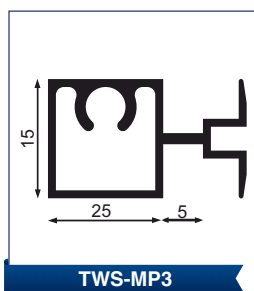
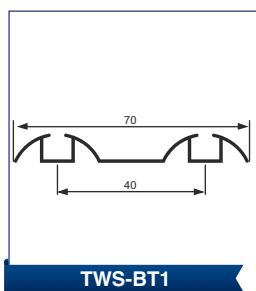
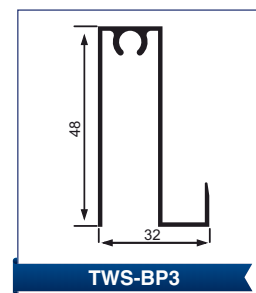
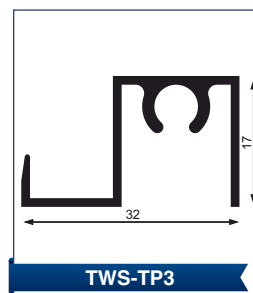
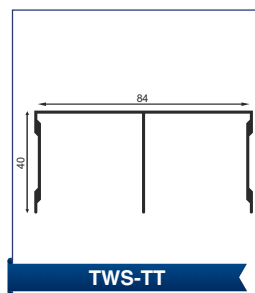
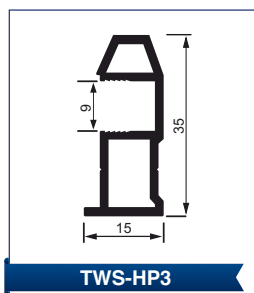
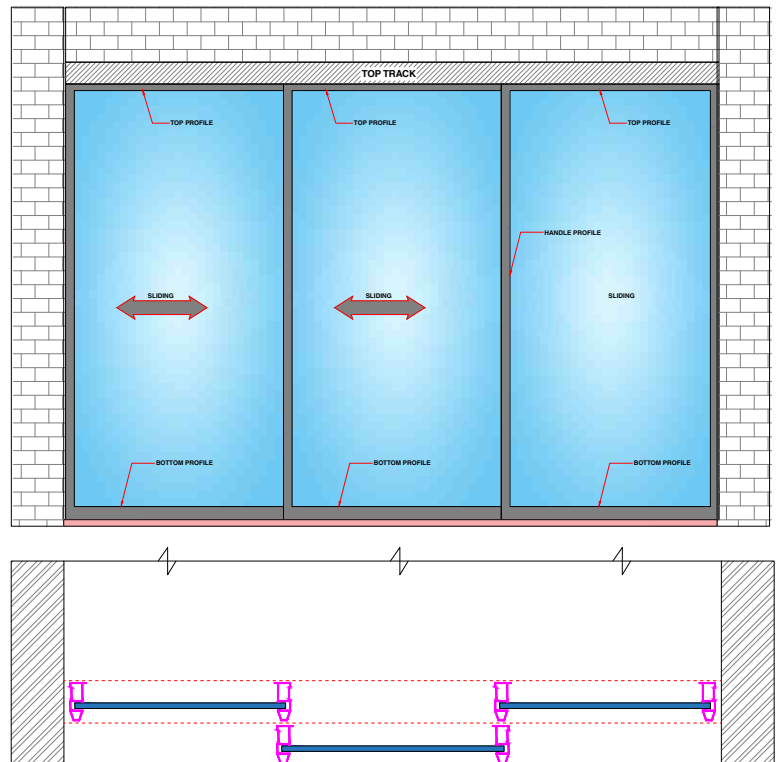

INSTALLATION INSTRUCTIONS

Vertical Profile Installation Instruction

$L_v = L_a - L_{w1} - L_{w2}$

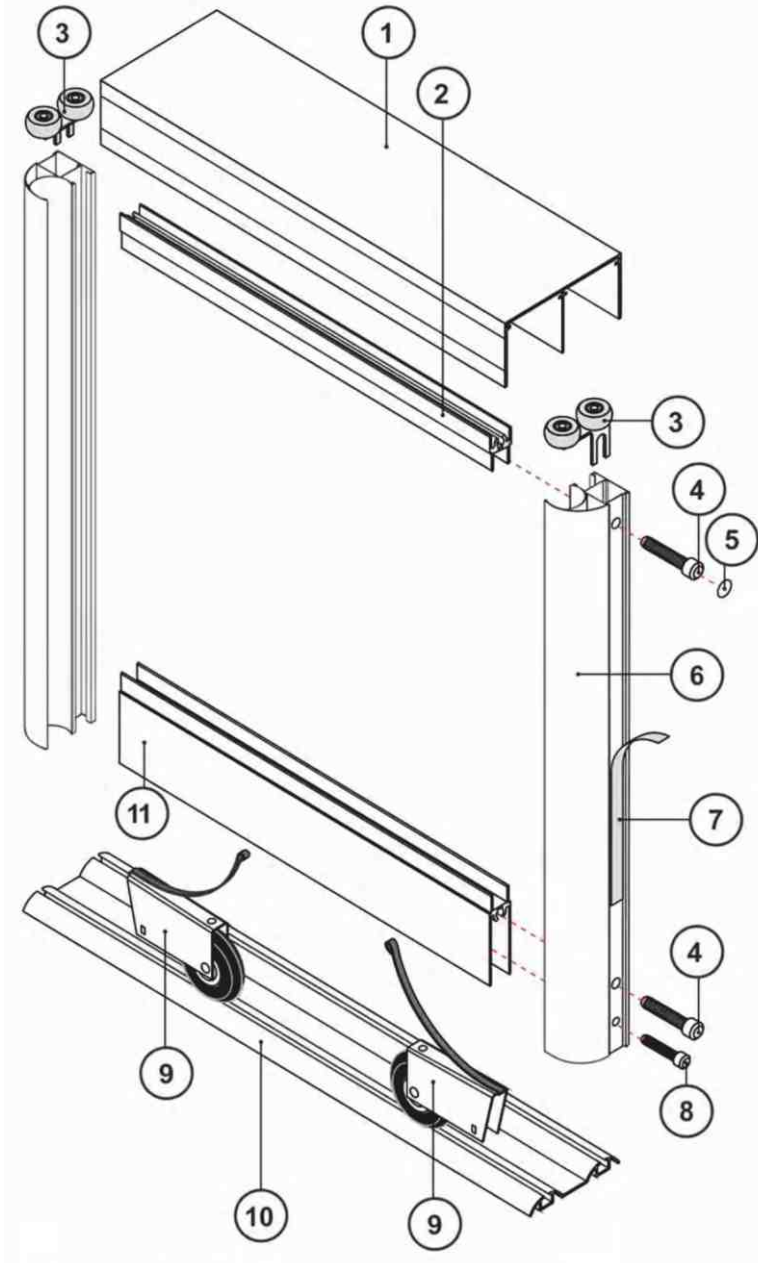
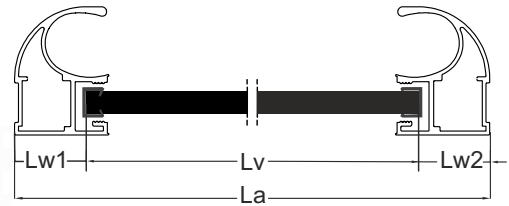

Top & Bottom Track Installation Instruction

$HD = HS - 40MM$

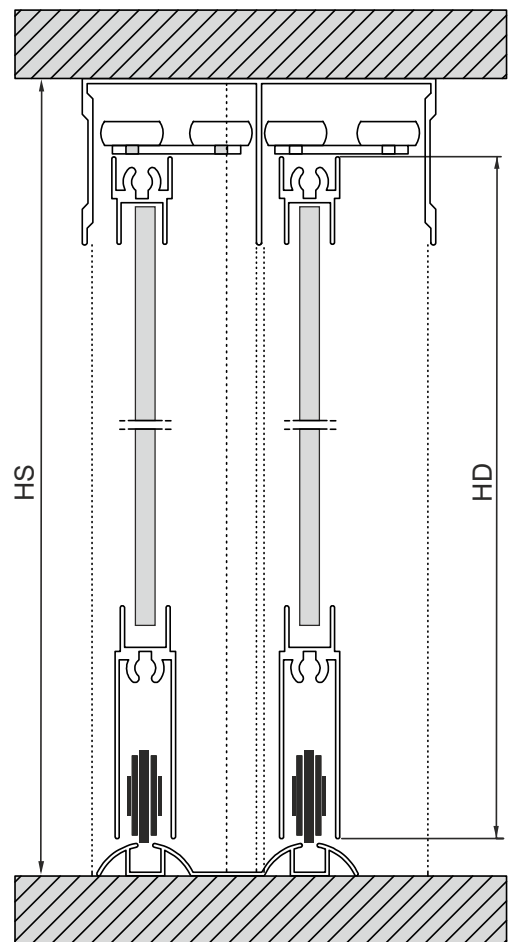

- 1. Top Track
- 2. Top Profile
- 3. Top Roller

- 4&5. Screw Fittings #1
- 6. Handle Profile
- 7. Brush Seal

- 8. Screw Fittings #2
- 9. Bottom Roller
- 10. Bottom Track
- 11. Bottom Profile



WARDROBE HYDRAULIC HINGES

Features:-

- ✦ Door Weight Capacity:- 20kg Max
- ✦ Door Hinge with 3D adjustment
- ✦ Opening angle 100
- ✦ Max Door Size: 450mm (W)x2400mm (H)
- ✦ Profile With inbuilt handle 200mm & 1150mm
- ✦ Handle Profile available in Left & Right option
- ✦ Suitable for 5mm thick Glass

Finish Color:-  SILVER RG BG BM

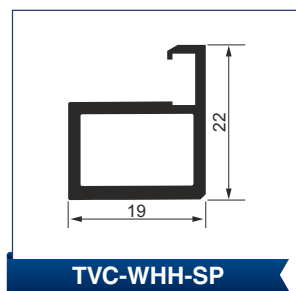
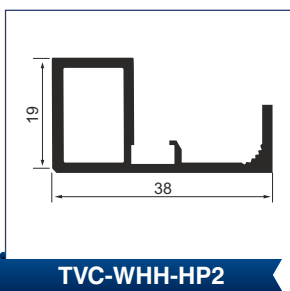
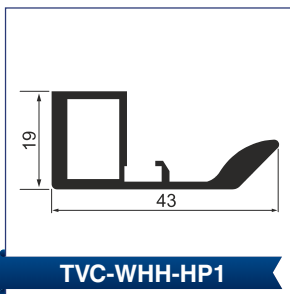
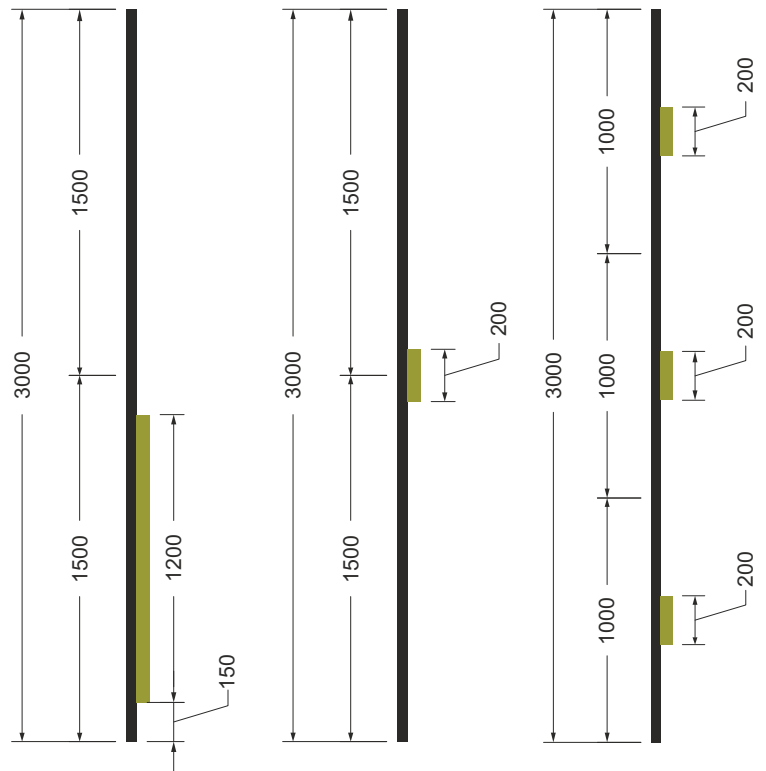



WARDROBE AIR HINGES

Features:-

- ✦ Door Weight Capacity: 40kg Max
- ✦ Heavy duty Air Hinges
- ✦ Max Door Size: 450mm (W)x2400mm (H)
- ✦ Profile with inbuilt handle 200mm & 1100mm
- ✦ Handle profile available in Left & Right option
- ✦ Suitable for 5mm thick Glass
- ✦ Applicable Cabinets: Cupboard/Bookcase,
- ✦ Vestibule/Wine Cabinet Wardrobe/ TV Cabinet

Finish Color:-

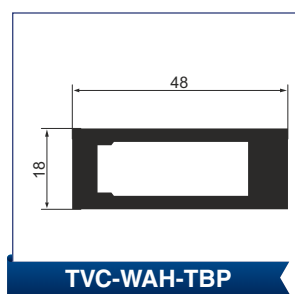
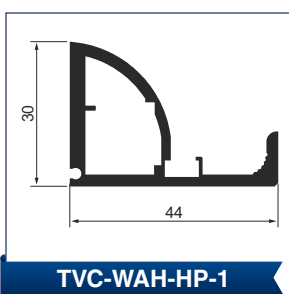
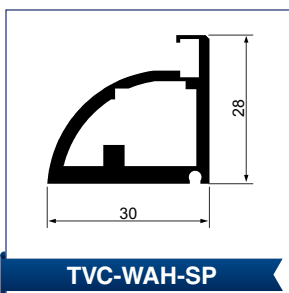
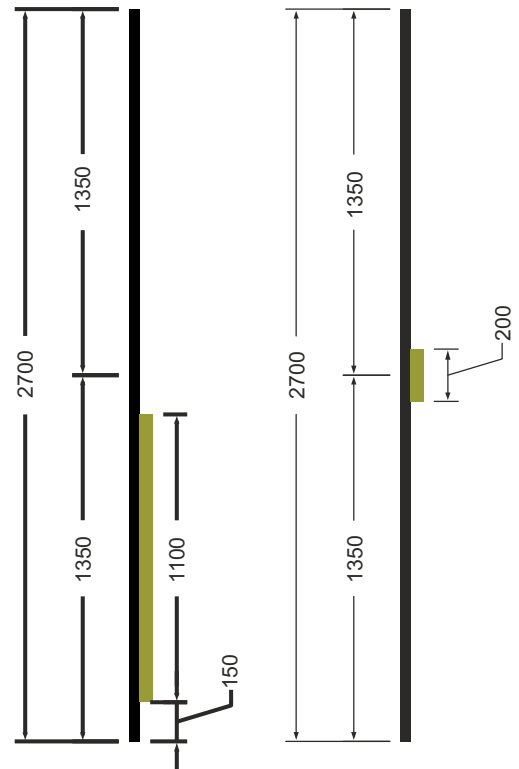



WARDROBE EDGE HANDLES

Features:-

- + Edge handles for openable wooden wardrobes
- + Profile Length: 2700mm
- + Suitable for 18mm thick Ply
- + Handle Profile available in Left & Right option

Finish Available:-

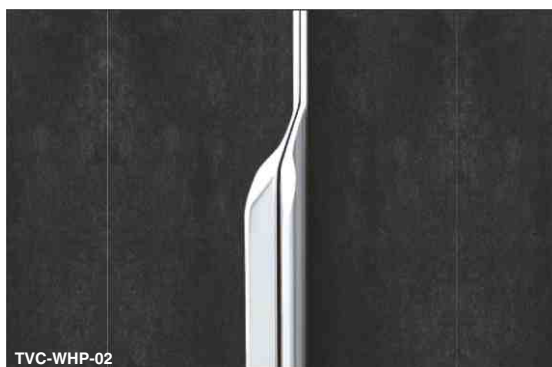
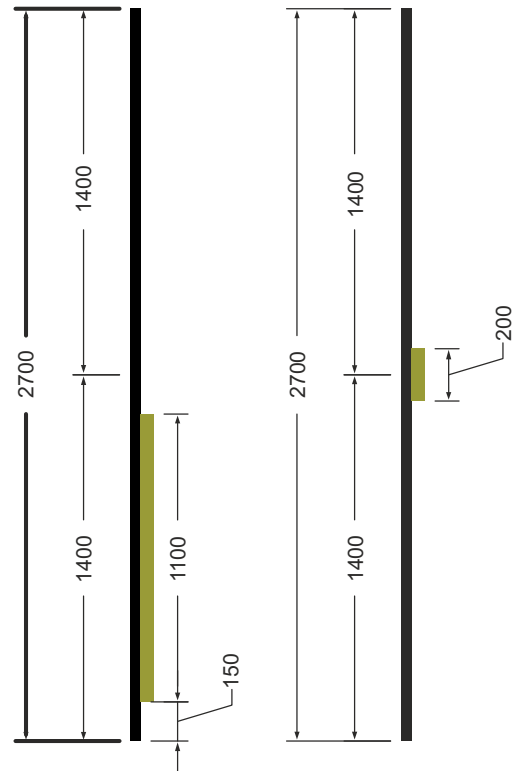
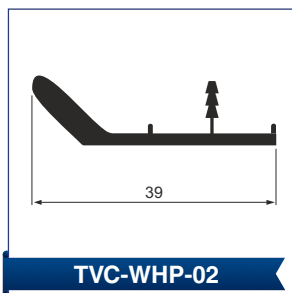
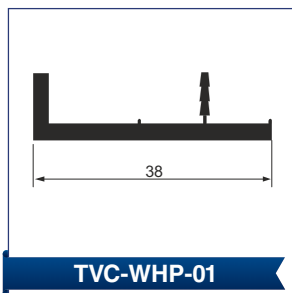



DRAWER HEDGE HANDLES

Size & Finish Available:-

+ 800mm & 500mm

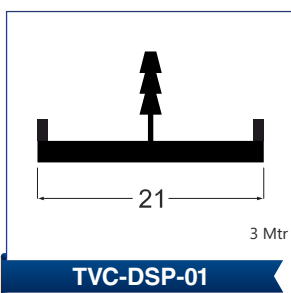
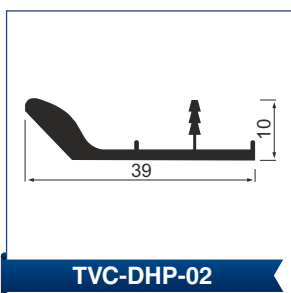
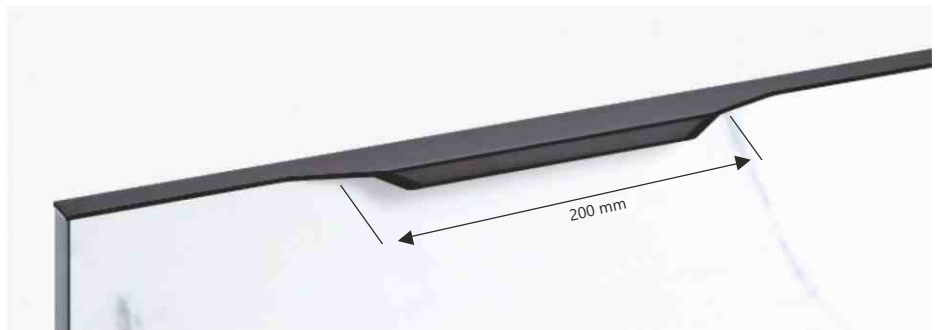
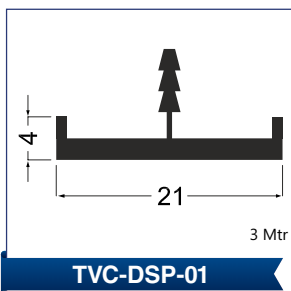
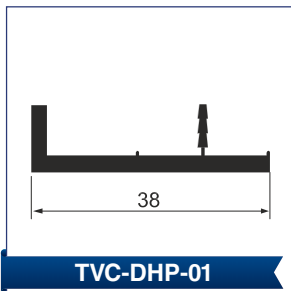





AUTOMATIC SLIM FRAMED SLIDING SYSTEMS

SPECIFICATION:

✦ Wt. Capacity	: 80kg
✦ Door Thickness	: 45mm
✦ Door Height Formula	: H-125
✦ Door Width	: 750mm
✦ Sound	: 40dB
✦ Power Consumption	: 100W
✦ Voltage	: 220V dc

EXCLUSIVE
RANGE

Product accessories

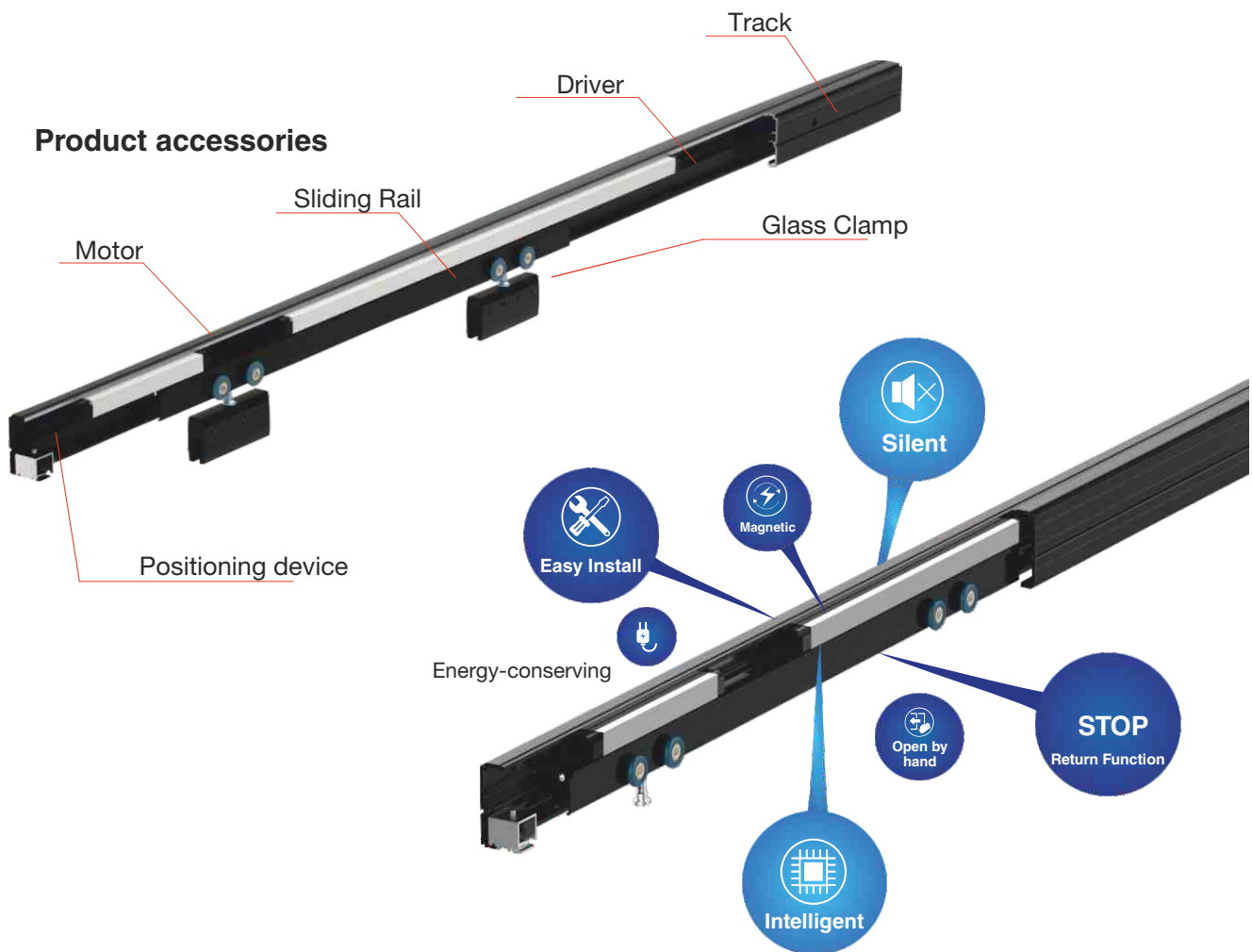

Features:

- ✦ Suitable for single or multiple sliding doors.
- ✦ Suitable for sliding doors for residences, hotels, office buildings.
- ✦ Motorless electromagnetic drive, App background setting, device, power of working mode, CE certification.
- ✦ Can be integrated with wireless button switch, fingerprint switch, password switch, microwave induction switch & face recognition switch.

Material & Finishes:

- ✦ Sliding Track: Aluminum & Anodized
- ✦ Hanging roller: Zinc Alloy & SN
- ✦ Bracket: Iron & SN
- ✦ Color: Black Matte

TAV-3+1-MG

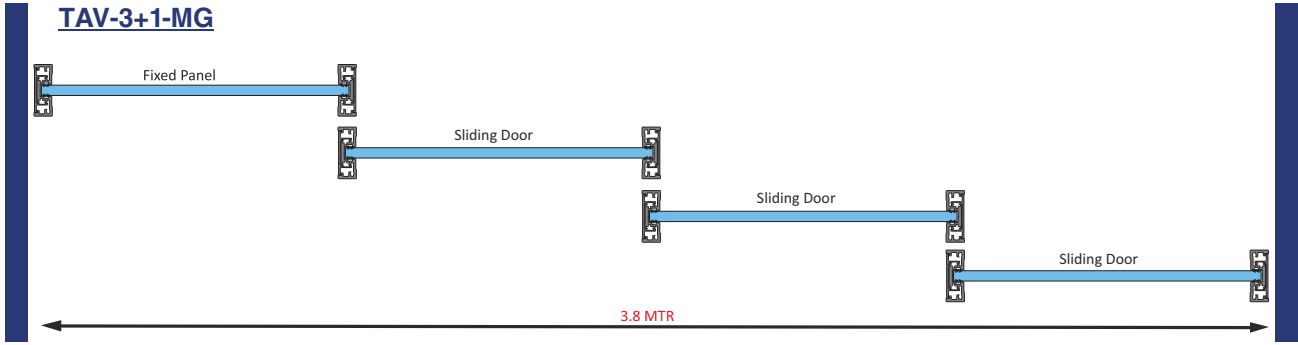

TAV-OPP-2+2 MG

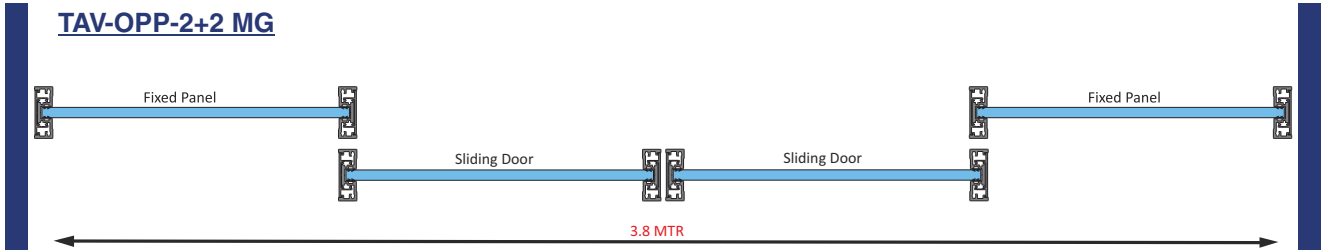

TAV-2+1-MG

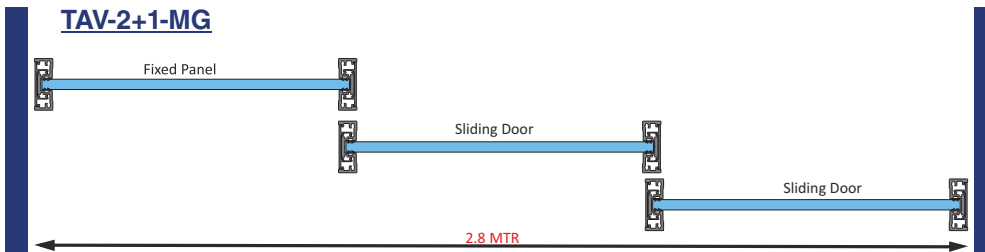

TAV-1+1-MG

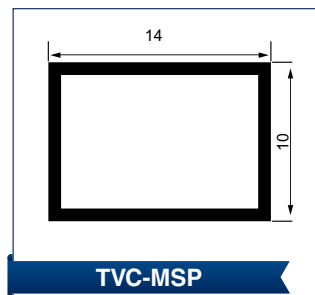
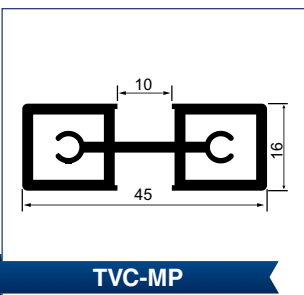
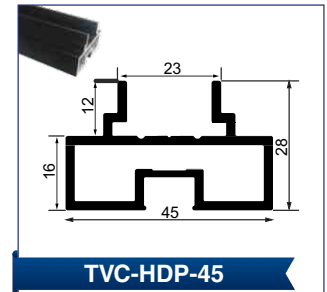
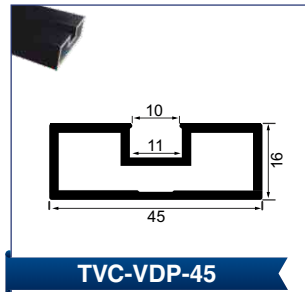
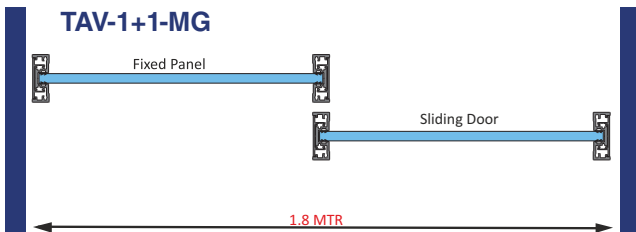



SLIM FRAMED SWING DOOR

Features:

- ✦ Max Door width 1100mm
- ✦ Floor Spring to be ordered according to Door height & Door width.
- ✦ Color: Brush Gold, Black Matte, Rose Gold, Grey, Champagne.

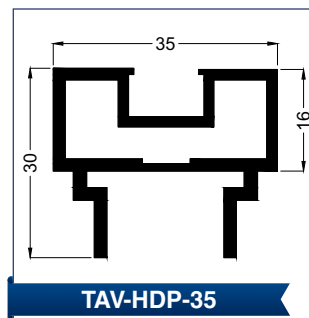
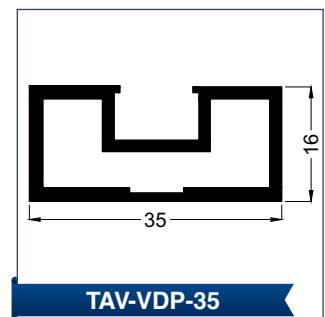
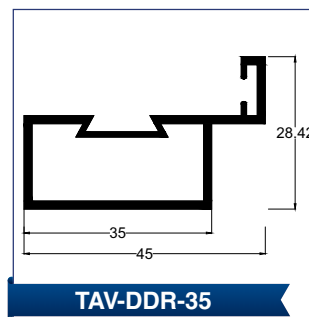
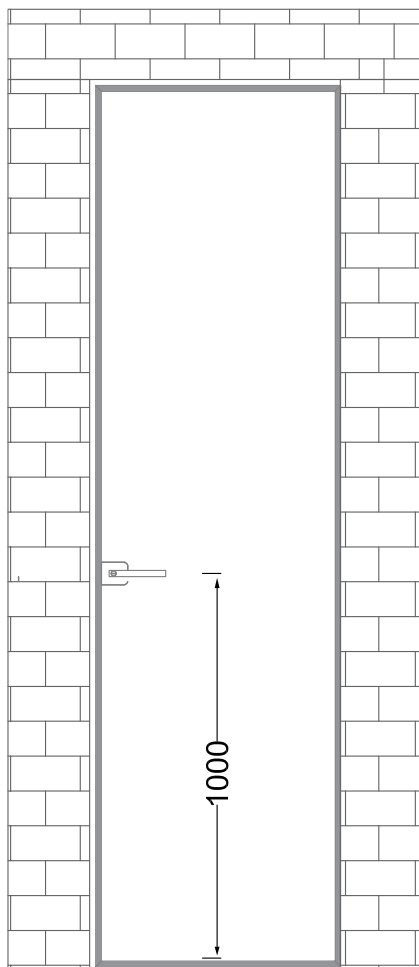
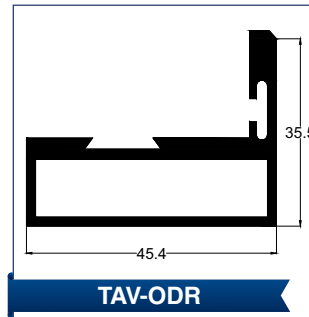



MANUAL WOODEN SLIDING SYSTEMS

SPECIFICATION:

- ✦ Wt. Capacity : 80kg
- ✦ Door Thickness : 30-45mm
- ✦ Door Height Formula : H-85mm
- ✦ Door Width (Telescopic) : 700-950mm
- ✦ Door Width (Bi-parting) : 700-950mm

Finish Available:-

- ✦ Black Matt, Brush Gold, Rose Gold, Grey & Champagne.

TAV-3+1 WD

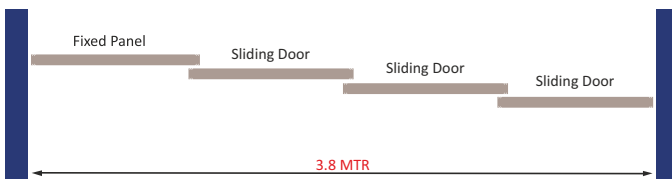

TAV-2+1 WD

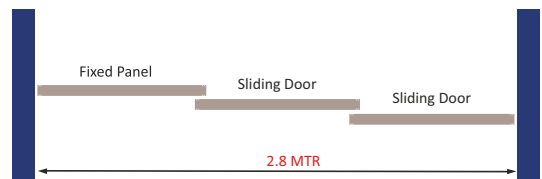

TAV-OPP-2+2 WD

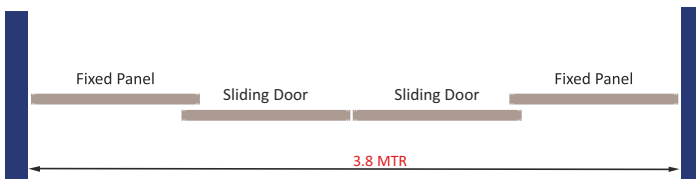

TAV-1+1 WD

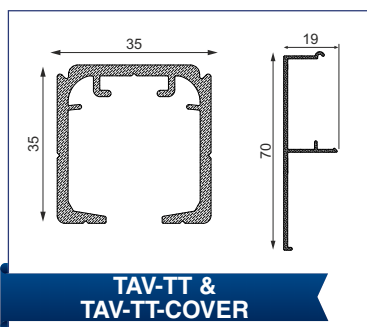
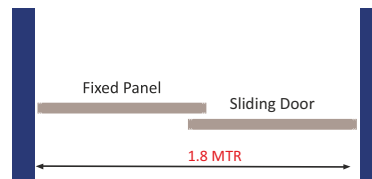

TAV-TT & TAV-TT-COVER



TAV-WD-FH



TAV-3-WD-KIT



TAV-2-WD-KIT



TAV-1-WD-KIT



TAV-OPP-2-WD-KIT

MANUAL SLIM FRAMED SLIDING SYSTEMS



TVV-SDL



TAV-DL-35



TAV-H-35



TAV-CH-35



TAV-TH-35

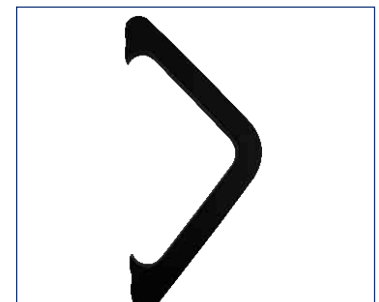

TELESCOPIC SLIDING SYSTEM ACCESSORIES



- 1 Agra
- 2 Bangalore
- 3 Bhubaneswar
- 4 Calicut
- 5 Chandigarh
- 6 Chennai
- 7 Coimbatore
- 8 Dehradun
- 9 Dharamshala
- 10 Gujrat
- 11 Gurgaon
- 12 Guwahati
- 13 Haridwar
- 14 Hyderabad
- 15 Kochi
- 16 Kolhapur

OUR PRESENCE



- 17 Kolkata
- 18 Kota
- 19 Lucknow
- 20 Ludhiana
- 21 Madurai
- 22 Mohali
- 23 Mumbai
- 24 New Delhi
- 25 Nashik
- 26 Noida
- 27 Pune
- 28 Salem
- 29 Shimla
- 30 Trivandrum
- 31 Vijayawada
- 32 Vizag



Scan QR Code for Website

Follow us on:



BEST SUITED FOR



Residences



Retail Store



Hospitality



Educational Institutions



Shopping Malls



AirPorts



Automobile Showrooms



Commercial Buildings



Sports Complex



Corporate Offices



HYDERABAD

#8-3-677/21, Sri Krishna
Devaraya Nagar, Yellareddyguda,
Hyderabad - 500073
Tel : +91-9063090009
E-mail : customercare@taiton.in

KERALA (CALICUT)

Door No 65/3058, Ground Floor
Meridiyan Mansion Shopping
Complex Near Manorama Jn,
Wayanad Road, Calicut – 673001
Ph no: 0495 4013355, 9946104308,
9946104309, 8129124452

TAMIL NADU (CHENNAI)

+91 9677006697

ANDHRA PRADESH (VIJAYAWADA)

+91 9553527711

NEW DELHI

D-15A, FF, Lajpat Nagar II,
New Delhi - 110024
Tel : +91-11- 35551720, 45040117
E-mail : taitondelhi@taiton.in

KERALA (TRIVANDRUM)

TC 84/2248 (1), Ground floor
NH Bypass, Enchakkal
Thiruvananthapuram Pin – 695008
Ph no: 0471 2476315, 8129124452

BANGALORE

SM Lake Pride, #168,
13th Main Road,
Sector 5, HSR Layout,
Bangalore - 560102
Tel : +91-9591491115

KERALA (COCHIN)

Door No. 42/2200 C to C5
Arakkakadavu Road
Vennala P.O, Ernakulam - 682028
Ph no: 0484-3522156
9946104308, 9946104309
Email : vm@taiton.in

www.taiton.in

AHMEDABAD, RAJKOT, SURAT EXPORTS

+91 7428097601
exports@taiton.in

MAHARASHTRA (PUNE)

+91 8999920000

Auth. Partner