

JW SPORT

A STRONG COMPANION FOR YOUR SUCCESS

JW Sport (USA) INC

Phone ++(949) 807 8910

Address: 9950 Lrvine Center Dr.SULTE #150.Lrvine CA,92618

JW Sport GmbH

JW Sport (China)

International Website: www.jw-sport.com





JW SPORT

Since its birth in 2013, JW has been constantly pursuing innovation and excellence. With an extraordinary modern vision, it reinterprets the evolution and transformation of fitness equipment. Focusing on enhancing customer excellence, it elaborates on the definition of high-end fitness equipment and consolidates the classic brand status of JW fitness equipment. While pursuing excellence, JW also represents the attention and level of the current equipment manufacturing industry to details and quality, and continuously presents romantic, modern and passionate aesthetic concepts to users.

In nearly eight years, JW has successfully laid out in major cities in China and achieved great success in the Chinese fitness market. In high-end commercial fitness clubs, star-rated hotels and enterprises and institutions in mainstream cities, JW always provides customers with a higher value service system and better fitness equipment from the perspective of the essential needs of the market. The innovative and subversive design concept has gained extremely high recognition in the Asian fitness circle. It has led the trend in the field of high-end commercial fitness equipment. JW has always been committed to being a leader of international first-tier brands. It is determined to create a fitness equipment brand that can best meet essential needs.

JW SPORT TOWN

At JW SPORT TOWN, everyone here is creative, innovative, and motivated. This is the exact place where we make JW happen. We would love to have you at JW SPORT TOWN. The moment you land, you will be amazed by how we build the finest fitness equipment, and there is no doubt you will love this place.



OUR PRODUCT

We carry all kinds of fitness equipment, covering aerobic equipment, strength machines and free weight benches etc. With elements of high standard, safety and innovation, we create many unique and popular products. This is how we take JW spirit into practice and make difference.



JW SPORT

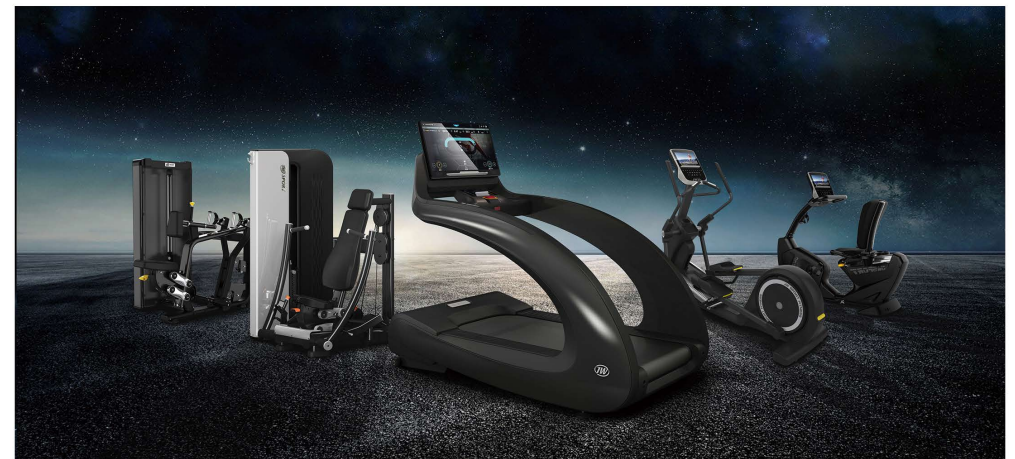

JW Sport (USA) INC

Phone: +(949) 807 8910

Address: 9050 Irvine Center Dr, Suite #150, Irvine CA, 92618

JW Sport GmbH

JW Sport (China)

International Website: www.jw-sport.com



YS-880T

ARTHUR Commercial Treadmill

Elegant look with boundless, fully wrapped inverted handrails. Integrating excellent biomechanical Design allowing fitness centers and users to enjoy the benefits, while being in accordance with fashion design philosophy.



JW SPORT, A Strong Companion for Your Success.



Touch Screen

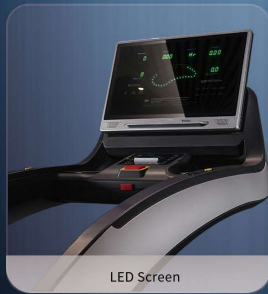

LED Screen

Excellent Performance. Extraordinary

4.0 HP Powerful Motor.
High-powered driving system uncovers more physical potential.
Achieve breakthroughs easily, steadily and vigorously.

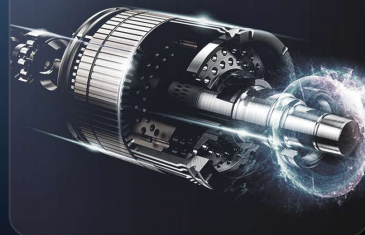

Stunning Appearance Vibrant

fully wrapped handrail design.
Integrate dynamic usability and nobility. Demonstrates sensual beauty



Exquisite Craft Ingenuity

Molds designed by inventive European partners
Detailed finishing with rigorousness and neatness
Quality demonstrated through small details

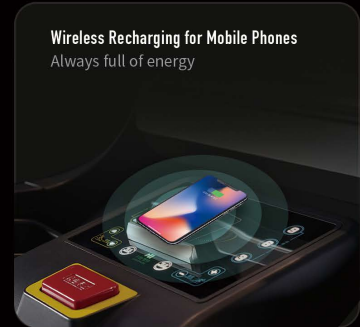

Wireless Recharging for Mobile Phones
Always full of energy

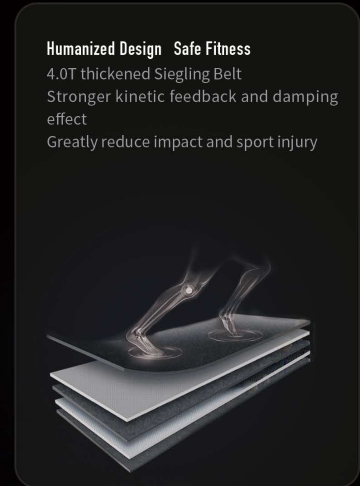

Humanized Design Safe Fitness

4.0T thickened Siegling Belt
Stronger kinetic feedback and damping effect
Greatly reduce impact and sport injury



Lift/Lower Screen with One Single Tap

Quality demonstrated through small details



Features

Display Type: 27" screen
Uprights: fully wrapped with plastic; steel frames
Running Belt: 4.0mm thickness;
Working temperature: -10~70°C
Running Board: Highest strength; 25mm thickness; static load capacity: 600KG/1323lbs.
Elevator motor: Voltage:200-240V; Output power:60W

Running Belt: 580 mm (Width)22.8in
Main Motor: Rated power: 4.0HP (3.0KW)
Power Source: External power supply; AC 220V±10% (50Hz/60Hz)
Power Cord:16A AC 250V
Overload Protector: 13A
Static capacity: 150KG/330lbs

Unit Weight (LED console): 290kg/639lbs
Unit Weight (TFT console): 300kg/661lbs
Dimensions: (L*W*H) 2150*970*1850mm/84.6*38.2*72.8in
Running Surface: 580*1470 mm/22.8*57.9in

S-800

Commercial Treadmill

Sleek and elegant in appearance, with a powerful and restrained overall design, the high-tech design concept exudes a sense of nobility and uniqueness, while ensuring stability and safety during sports.

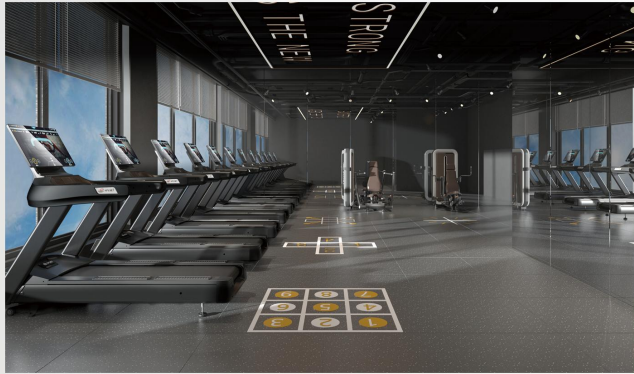

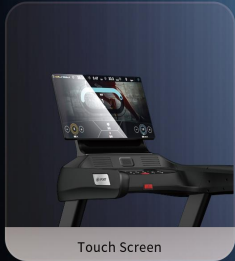

Touch Screen



LED Screen

The user manual

23.6-inch LED screen interface, multi-window display 32-inch touchscreen TFT monitor. TFT features a new year GAP capacity touchscreen with IPS full-view LCD screen. When the user presses a button, the touch space will play a click sound for simple operation and quick response.



Heart rate monitoring

Embedded heart rate sensor, real-time and accurate display of heart rate and calories, helping users stay in the fat burning, aerobic, or peak target zone for more effective cardio training and weight loss.



Entertainment functions

Supports installation of various Android version applications, USB interface, and WIFI wireless network support for various video online playback and picture browsing, supports MP4 format.



Weight-bearing treadmill

High-strength 25T running board, maximum static load 600KG, high-quality shock absorption design, suitable for runners of different weights and strides, ensuring safe and comfortable use for excellent fitness results.

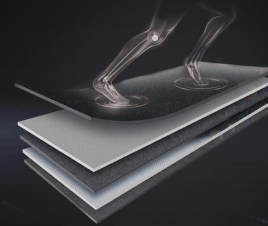

Quick operation panel

Convenient control panel, one-key quick program switching, emergency stop and emergency brake buttons to ensure exercise safety.



Features

Dimensions:
LED: 2350*1005*1740mm/925.2*39.57*68.15 in
TFT: 2350*1005*1780mm/925.2*39.57*70.00 in
Running Belt:
T4.0*560*3675mm/T0.16*22.05*144.29 in
Unit Weight:
LED: 230KG/507.06 lbs TFT: 255KG/562.21 lbs

Overload Protector: 13A
Power Source:
External power supply; AC 220V±10% (50Hz/60Hz)
Power Cord: 1.6A AC 250V

Voltage: 200V-240V Output power: 60W
Language: LED: English
TFT: Chinese and English

M-9908EL

Elliptical



Touch Screen



LCD Screen

Function Parameters

User Interface	Extra-large high-precision screen is adopted to display resistance, speed, time and other readouts at all times and help you to monitor your workout status in real time.
Resistance System	Advanced ECB magnetic control resistance system are safer and more reliable.
Plate Supporting Structure	Aluminium alloy sliding rail, large diameter crown type bearing, and 8mm thickness high-strength steel plates.
Heart Rate Monitoring	Contact heart rate monitoring enables the user to measure heart rate at any time.
Kinesiology	International advanced technology makes movement trajectory completely conform with body structure and kinesiology principle.
Super Luxury	Super luxurious PU foam handlebar and environment-friendly TPR keys.
Unique Ramp Design	Unique ramp design; function of stair climber included.
Strengthened Support	3mm thickness strengthened steel tube supports console; which immensely enhances exercise stability and safety of supporting structure.

Basic Information

Display type	LED (default) /11.6" TFT (optional)
Unit Dimensions	2300*790*1810mm (L*W*H)90.5*31.1*71.2in
Resistance Range	0-15
Languages	English
Maximum Load	150kg/330lbs
Unit Weight	166 KG/365.2lbs
Incline range	0-15

JW Sport (USA) INC

Phone: +1(949) 807 8910

Address: 9050 Irvine Center Dr, Suite #150, Irvine CA, 92618

JW Sport GmbH

JW Sport (Shanghai) Co., Ltd

International Website: www.jw-sport.com

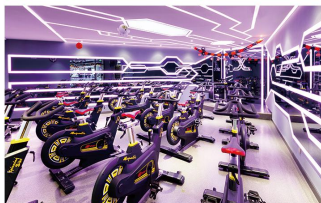

M-5812

Indoor Bike

Handlebar and seat design which complies with the principle of human engineering and gearshift resistance adjustment enables users to get comfortable. Riding experience; frictionless Magnetic control mode prolongs the service life of the braking system.





M-5812

Indoor Bike

Function Parameters

Fore/aft adjustment of seat and free regulation of handlebar makes the ergonomically designed unit suitable for different users.

Adjustable pedals bring comfort during workouts.

The overall design of heavy flywheel and low center of gravity provides the user the feeling of better stability

High-strength pedals ensure workout safety.

The belt drive style brings dual-direction spinning and free options; transport wheels on base tubes make transportation easier and safer.

Gearshift resistance adjustment brings similar user experience as by a real road bicycle.

Frictionless magnetic control mode prolongs the service life of braking system.

Basic Information

Unit Weight	88KG/193.6lbs
Maximum Load	150KG/330lbs
Unit Dimensions	1660*700*1445mm/65.4*27.5*56.9 in

JW Sport (USA) INC

Phone: +(949) 807 8910

Address: 9050 Irvine Center Dr, Suite #150, Irvine CA, 92618

JW Sport GmbH

JW Sport (Shanghai) Co., Ltd

International Website: www.jw-sport.com

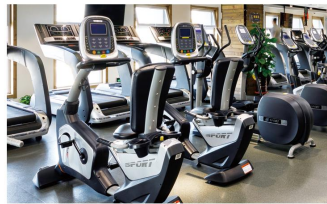

M-8808R

Recumbent Bike

Sturdy design and intuitive console make it easy and convenient to use. Fashionable look and good durability enable it to be an asset suitable for any fitness center. It can be connected to Wi-Fi and operated through service management, and provide data and recommendations on preventive maintenance



JW SPORT, A Strong Companion for Your Success.



Touch Screen



LCD Screen

M-8808R

Recumbent Bike

Function Parameters	
User Interface	11.6" extra large touch screen, interface similar as smart phone; different pages for functions can be selected with taps on screen; more intuitive operation, quick response.
Entertainment Feature	Music, videos and pictures are available by inserting U disk or memory card; built-in analog&digital TV allows you to watch favourable programmes while having exercise.
Keyboard Shortcuts	Resistance, speed, quick start.
Heart Rate Monitoring	Digital heart rate monitoring system with contact heart rate sensor chip equipped measures your heart rate precisely. Remote (optional wireless chest strap required) heart rate monitoring system provides precise measurement and frees your hands.
Workout Modes	Intelligent resistance adjustment; 20 levels.

Basic Information	
Heart Rate Monitoring	contact and remote (optional wireless chest strap required) heart rate monitoring
Resistance Range	0-20
Maximum Load	150KG/330lbs
Power Source	External power supply; AC 220V±10% (50Hz/60Hz)
Unit Dimensions	(L*W*H)1920*610*1630mm/75.6*24.0*64.2in
Unit Weight	94 KG/206.8lbs
Readouts	Time, Distance, Calories, Power, Heart rate, Speed.

JW Sport (USA) INC

Phone: +1(949) 807 8910

Address: 9050 Irvine Center Dr, Suite #150, Irvine CA, 92618

JW Sport GmbH

JW Sport (Shanghai) Co., Ltd

International Website: www.jw-sport.com



M-8808U

Upright Bike

Ergonomical design; adjustable seat. Improved durability and comfort. It can be connected to Wi-Fi and connected to back office for better maintenance and service.



JW SPORT, A Strong Companion for Your Success.



Touch Screen



LCD Screen

M-8808U

Upright Bike

Function Parameters

User Interface	11.6" extra large touch screen, interface similar as smart phone; different pages for functions can be selected with taps on screen; more intuitive operation, quick response.
Entertainment Feature	Music, videos and pictures are available by inserting U disk or memory card; built-in analog&digital TV allows you to watch favourable programmes while having exercise.
Keyboard Shortcuts	Resistance, speed, quick start.
Heart Rate Monitoring	Digital heart rate monitoring system with contact heart rate sensor chip equipped measures your heart rate precisely. Remote (optional wireless chest strap required) heart rate monitoring system provides precise measurement and frees your hands.
Workout Modes	Intelligent resistance adjustment; 20 levels.

Basic Information

Track	Material: high-strength aluminum alloy; Process: extrusion moulding.
Frame	60*120 Elliptical pipe
Power Source	External power supply; AC 220V±10% (50Hz/60Hz)
Unit Dimensions	(L*W*H)1135*590*1570mm /44.7in*62.6in*61.8 in
Unit Weight	<N.W.> 69KG/152 lb
Readouts	Time, Distance, Calories, Power, Heart rate, Speed.
Handlebar	high-density foam handlebar feels soft and comfortable during workouts.

TRANSCEND SERIES

STRENGTH EQUIPMENT

Transcend Series (TS) are designed with three years developing and Testing by our international R&D team, we are not only focusing on its durability, but also trying to design biomechanically sound product that can provide reliable performance and effective results for the exercisers.



Chest Press TS-001

Size:(L*W*H)1410*1075*1595mm/55.51*42.32*62.79 in
Weight stack: 120 kg/264.55 lbs
N.W:308.3kg/679.68 lbs



Pec Fly TS-002

Size:(L*W*H)1725*1365*1595mm/67.91*53.74*62.79 in
Weight stack: 120 kg/264.55 lbs
N.W:265kg/584.22 lbs



Pec Fly/Rear Delt TS-002A

Size:(L*W*H)1445*1310*2060mm/56.88*51.57*81.10 in
Weight stack: 60 kg/132.27 lbs
N.W:233.2kg/514.11 lbs



Shoulder Press TS-003

Size:(L*W*H) 1440*1640*1595mm/56.69*64.56*62.79 in
Weight stack: 80 kg/176.36 lbs
N.W:268.2kg/591.27 lbs



DELTS MACHINE TS-003A

Size:(L*W*H)1260*1255*1595mm/49.6*49.4*62.79 in
Weight stack:80kg/176.36 lbs
N.W:267.8kg/590.39 lbs



SEATED ROW TS-004

Size:(L*W*H)1340*1260*1595mm/52.75*49.6*62.79 in
Weight stack:120kg/264.55 lbs
N.W:271.2kg/597.89 lbs



ASSISTED CHIN /DIP TS-008

Size:(L*W*H)1560*1555*2260mm/61.41*61.22*88.97 in
Weight stack:80kg/264.55 lbs
N.W:295kg/656.97 lbs



LOWER BACK TS-009

Size:(L*W*H) 1400*1015*1595mm/56.69*39.96*62.79 in
Weight stack: 120 kg/264.55lbs
N.W:256kg/564.38 lbs



BICEPS CURL TS-006

Size:(L*W*H) 1180*1475*1595mm/46.45*58.07*62.79 in
Weight stack:80kg/176.36 lbs
N.W:255.3kg/562.84 lbs



TRICEPS PRESS TS-007

Size:(L*W*H)980*1295*1595mm/38.58*50.98*62.79 in
Weight stack:120kg/264.55 lbs
N.W:257kg/566.58 lbs



ABDOMINAL CRUNCH TS-010

Size:(L*W*H)1260*1170*1595mm/49.6*46.06*62.79in
Weight stack:80kg/176.36 lbs
N.W:233.6kg/514.99 lbs



ROTARY TORSO TS-011

Size:(L*W*H)1220*1170*1595mm/48.03*46.06*62.79 in
Weight stack:80kg/176.36 lbs
N.W:224kg/493.83 lbs



LAT PULL DOWN

TS-012

Size:(L*W*H)1425*1300*1890mm/56.1*51.18*74.4 in
Weight stack:120kg/264.55 lbs
N.W:286kg/630.52 lbs



SEATED LEG CURL

TS-013

Size:(L*W*H)1410*960*1595mm/55.51*37.79*62.79 in
Weight stack:120kg/264.55 lbs
N.W:260.3kg/573.86 lbs



LEG PRESS

TS-015

Size:(L*W*H)1980*1120*1595mm/77.95*44.09*62.79 in
Weight stack:150kg/330.69 lbs
N.W:340kg/749.57 lbs



STANDING LEG EXTENSION

TS-016A

Size:(L*W*H)1840*900*1595mm/72.44*35.43*62.79 in
Weight stack:80kg/176.36 lbs
N.W:271kg/597.45 lbs



HORIZONTAL LEG CURL

TS-013A

Size:(L*W*H)1435*965*1595mm/56.49*37.99*62.79 in
Weight stack:80kg/176.36 lbs
N.W:255kg/562.17 lbs



LEG EXTENSION

TS-014

Size:(L*W*H)1380*1020*1595mm/54.33*40.15*62.79 in
Weight stack:120kg/264.55 lbs
N.W:289.4kg/638.01 lbs



CALF EXTENSION

TS-017

Size:(L*W*H)1655*1020*1595mm/65.15*40.15*62.79 in
Weight stack:120kg/264.55 lbs
N.W:277kg/600.44 lbs



INNER THIGH ADDUCTOR

TS-018

Size:(L*W*H)1700*845*1595mm/66.92*33.26*62.79 in
Weight stack:120kg/264.55 lbs
N.W:276kg/608.47 lbs



OUTER THIGH ABDUCTOR TS-019

Size:(L*W*H) 1700*845*1595mm/66.92*33.26*62.79 in
Weight stack: 120 kg/264.55 lbs
N.W: 276kg/608.47 lbs

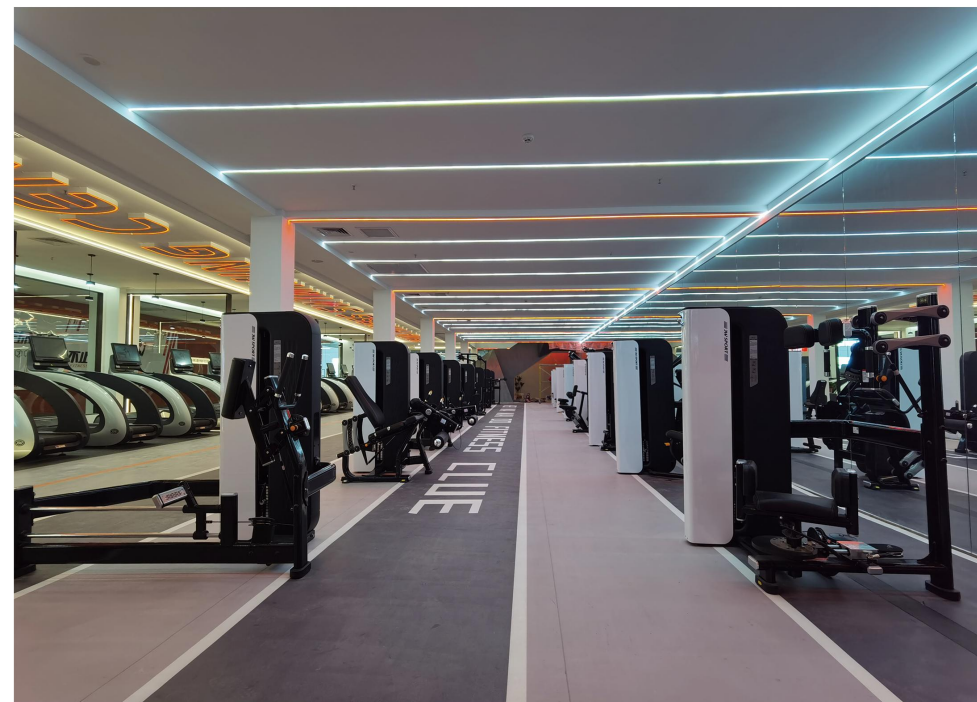



YS-SERIES

Strength Equipment

In order to create the perfect interaction between the exerciser and the equipment, YS-SERIES combines cool visuals with attractive design, setting a new standard in counterweight strength equipment. Distinctive color matching-Downton Silver Gray with Brown.

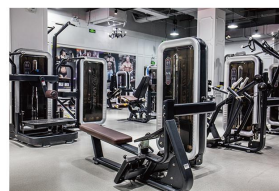



YS-001 CHEST PRESS

Product weight: 278.5KG
Max load weight: 100KG
Dimensions: 1140*1355*1595mm(L*W*H)



YS-002 PEC FLY

Product weight: 252KG
Max load weight: 80KG
Dimensions: 1080*1355*1595mm(L*W*H)



YS-003A DELTS MACHINE

Product weight: 246.7 KG
Max load weight: 80 KG
Dimensions: 1315*1305*1595mm(L*W*H)



YS-004 SEATED ROW

Product weight: 257.5 KG
Max load weight: 100KG
Dimensions: 1365*1320*1595mm(L*W*H)



YS-002A PEC FLY/REAR DEL

Product weight: 255KG
Max load weight: 100KG
Dimensions: 1510*1150*2060mm(L*W*H)



YS-003 SHOULDER PRESS

Product weight: 252KG
Max load weight: 80KG
Dimensions: 1630*1510*1595mm(L*W*H)



YS-006 BICEPS CURL

Product weight: 227.5KG
Max load weight: 80KG
Dimensions: 1320*1415*1595mm(L*W*H)



YS-007 TRICEPS PRESS

Product weight: 246.7KG
Max load weight: 100KG
Dimensions: 1255*1015*1595mm(L*W*H)



YS-008 ASSISTED CHIN/DIP

Product weight: 303KG
Max load weight: 80KG
Dimensions: 1665*1630*2265mm(L*W*H)



YS-009 LOWER BACK

Product weight: 253KG
Max load weight: 100KG
Dimensions: 1355*1030*1595mm(L*W*H)



YS-012 LAT PULL DOWN

Product weight: 306 KG
Max load weight: 100 KG
Dimensions: 1380*1340*2005mm(L*W*H)



YS-013 SEATED LEG CURL

Product weight: 281.5KG
Max load weight: 100KG
Dimensions: 1485*980*1595mm(L*W*H)



YS-010 ABDOMINAL CRUNCH

Product weight: 246KG
Max load weight: 80KG
Dimensions: 1330*1190*1595mm(L*W*H)



YS-011 ROTARY TORSO

Product weight: 243.5 KG
Max load weight: 80KG
Dimensions: 1330*1140*1595mm(L*W*H)



YS-013A HORIZONTAL LEG CURL

Product weight: 238.5 KG
Max load weight: 80KG
Dimensions: 1500*980*1595mm(L*W*H)



YS-014 LEG EXTENSION

Product weight: 246.7 KG
Max load weight: 80KG
Dimensions: 1445*1045*1595mm(L*W*H)



YS-015 LEG PRESS

Product weight: 336KG
Max load weight: 120KG
Dimensions: 1985*1160*1595mm(L*W*H)



YS-016A KICK BACK

Product weight: 242.5KG
Max load weight: 80KG
Dimensions: 1850*1085*1595mm(L*W*H)



YS-019 OUTER THIGH ABDUCTOR

Product weight: 278 KG
Max load weight: 120KG
Dimensions: 1560*930*1595mm(L*W*H)



YST-012 SEATED ROW/HIGH PULLEY

Product weight: 297KG
Max load weight: 100KG
Dimensions: 1560*1500*2210mm(L*W*H)



YS-017 CALF EXTENSION

Product weight: 267.5KG
Max load weight: 100KG
Dimensions: 1660*1070*1595mm(L*W*H)



YS-018 INNER THIGH ADDUCTOR

Product weight: 278 KG
Max load weight: 120KG
Dimensions: 1770*930*1595mm(L*W*H)



YS-1314 LEG CURL/LEG EXTENSION

Product weight: 297 KG
Max load weight: 80KG
Dimensions: 1440*1060*1595mm(L*W*H)



YS-01819 ADDUCTOR/ABDUCTOR

Product weight: 297 KG
Max load weight: 100KG
Dimensions: 1725*820*1595mm(L*W*H)

JW-SERIES

Strength Equipment

The JW Power series guard plate adopts a large area of semi-transparent frosted texture material, bidding farewell to the monotony of traditional equipment's cast iron in terms of touch, and presenting a reserved and luxurious visual effect. The entire design is filled with the most expensive regal air.



Chest Press JW-001

Size (L*W*H) : 1360*1550*1800mm/53.15*58.07*69.68in



蝴蝶机训练器 JW-002

Size (L*W*H) : 1260*1595*1615mm/49.61*62.76*63.58in



蝴蝶夹胸训练器 JW-002A

Size (L*W*H) : 1655*1125*2060mm/65.16*44.29*81.10in



肩部推举训练器 JW-003

Size (L*W*H) : 1645*1625*1555mm/64.61*64.02*63.58in



Seated Row JW-004

Size (L*W*H) : 1655*1125*2060mm/65.16*44.29*81.10in



Biceps Curl JW-006

Size (L*W*H) : 1260*1065*1615mm/49.61*41.93*63.58in



Lower Back JW-009

Size (L*W*H) : 1230*1140*1615mm/48.43*44.88*63.58in



Abdominal Crunch JW-010

Size (L*W*H) : 1385*1100*1615mm/54.53*43.31*63.58in



Triceps Press JW-007

Size (L*W*H) : 1210*1065*1615mm/47.64*41.93*63.58in



Assisted Chin/DIP JW-008

Size (L*W*H) : 1325*1275*2370mm/52.17*50.39*93.31in



Rotary Torso JW-011

Size (L*W*H) : 1120*1345*1615mm/44.09*52.91*63.58in



Seated Horizontal Pulley JW-012A

Size (L*W*H) : 1800*1135*1555mm/70.87*44.69*61.22in



Lat Pull Down JW-012B

Size (L*W*H) : 1535*1380*1990mm/60.43*54.33*78.35in



High Pulley JW-012C

Size (L*W*H) : 1350*1435*2290mm/53.15*56.50*90.16



Leg Extension JW-014

Size (L*W*H) : 1360*1160*1555mm/53.54*45.67*61.22in



Leg Press JW-015

Size (L*W*H) : 1980*1250*1555mm/77.95*49.21*61.22in



Seated Leg Curl JW-013

Size (L*W*H) : 1345*1485*1555mm/52.95*58.46*61.22in



Horizontal Leg Curl JW-013A

Size (L*W*H) : 1675*1125*1555mm/65.94*44.29*61.22in



Multi Hips JW-016

Size (L*W*H) : 1140*1200*1600mm/44.88*47.24*62.99in



Glute Kickback JW-016A

Size (L*W*H) : 1365*1050*1555mm/53.74*41.34*61.22in



Calf Extension JW-017

Size (L*W*H) : 1600*1175*1555mm/62.99*46.26*61.22in



Adductor & Abductor JW-018

Size (L*W*H) : 1675*720*1555mm/65.94*28.35*61.22in



Leg Extension / Leg Curl JWT-003

Size (L*W*H) : 1460*1175*1555mm/ 57.48*46.25*61.22 in



Chest / Shoulder press JWT-004

Size (L*W*H) : 1880*1510*1555mm/74.01*59.44*61.22 in



Biceps / Triceps JWT-001

Size (L*W*H) : 1195*1155*1555mm/47.04*45.47*61.22 in



High Pulley / Low Row JWT-002

Size (L*W*H) : 1560*1560*2210mm/ 61.41*61.41* 87 in



Lower Back / Abdominal Crunch JWT-005

Size (L*W*H) : 1375*1300*1555mm/54.13* 51.18* 61.22 in

US-SERIES

Universe

The new Universe Power series, with its vast and resolute cosmic spirit, presents a more sharp and dynamic posture, achieving a radiant and extraordinary combination of sports ergonomics and aesthetics.



STRENGTH EQUIPMENT

UNIVERSE





US-001 Chest Press

Product Size: 1347*1113*1606 mm
Weight Stack: 100 KG



US-002 Pec Fly

Product Size: 1482*1205*1606 mm
Weight Stack: 80 KG



US-007 Triceps Press

Product Size: 1314*950*1606 mm
Weight Stack: 100 KG



US-008 Assisted Chin/Dip

Product Size: 1327*1413*2369 mm
Weight Stack: 80 KG



US-02A Pec Fly

Product Size: 1528*1119*2058 mm
Weight Stack: 100 KG



US-003 Shoulder Press

Product Size: 1434*1613*1606 mm
Weight Stack: 80 KG



US-009 Lower Back

Product Size: 1300*1037*1606 mm
Weight Stack: 100 KG



US-010 Abdominal Crunch

Product Size: 1454*1012*1606 mm
Weight Stack: 80 KG



US-004 Seated Row

Product Size: 1369*951*1606 mm
Weight Stack: 100 KG



US-006 Biceps Curl

Product Size: 1317*960*1606 mm
Weight Stack: 80 KG



US-011 Rotary Torso

Product Size: 1146*1235*1606 mm
Weight Stack: 80 KG



US-012A Seated Horizontal Pulley

Product Size: 1787*999*1606 mm
Weight Stack: 100 KG



US-012C High Pulley

Product Size: 1344*1317*2288 mm
Weight Stack: 100 KG



US-013A Horizontal Leg Curl

Product Size: 1014*1695*1606 mm
Weight Stack: 80 KG



US-018 Adductor/Abductor

Product Size: 1564*805*1606 mm
Weight Stack: 100 KG



UST-03 Chest/Shoulder Press

Product Size: 1879*1430*1606 mm
Weight Stack: 80 KG



US-014 Leg Extension

Product Size: 1369*1042*1606 mm
Weight Stack: 80 KG



US-015 Leg Press

Product Size: 1954*1061*1606 mm
Weight Stack: 120 KG



UST-067 Biceps/Triceps

Product Size: 1400*1030*1606 mm
Weight Stack: 80 KG



UST-0910 Lower Back/Abdominal Crunch

Product Size: 1550*1185*1606 mm
Weight Stack: 80 KG



US-016A Glute Kickback

Product Size: 1164*930*1606 mm
Weight Stack: 80 KG



US-017 Calf Extension

Product Size: 1591*1078*1606 mm
Weight Stack: 100 KG



UST-12 High Pulley/Low Row

Product Size: 1553*1480*2208 mm
Weight Stack: 100 KG



UST-1314 Leg Extension/Leg Curl

Product Size: 1540*1030*1606 mm
Weight Stack: 100 KG

ZS - SERIES

The ZS series of counterbalanced strength equipment boasts a sleek and captivating appearance, embodying a perfect design concept and exquisite craftsmanship. With minimal setup adjustments required, it is extremely user-friendly, offering a convenient strength training solution.



ZS-01 SUPER HORIZONTAL MULTI PRESS

Color: Matte black
Seat cushion: Graphite black/Bentley brown
Product Size: 2300*1540*1470mm



ZS-01A SUPER VERTICAL CHEST PRESS

Color: Matte black
Seat cushion: Graphite black/Bentley brown
Product Size: 1980*1560*1465 mm



ZS-02 SUPER UPPER CHEST FLIGHT MACHINE

Color: Matte black
Seat cushion: Graphite black/Bentley brown
Product Size: 2140*1420*1465 mm



ZS-03 SUPER DELTOID PRESS

Color: Matte black
Seat cushion: Graphite black/Bentley brown
Product size: 2100*1420*1520 mm



ZS-03A SUPER INCLINED CHEST PRESS

Color: Matte black
Seat cushion: Graphite black/Bentley brown
Product Size: 1900*1530*1790 mm



ZS-04 super rowing

Color: Matte black
Seat cushion: Graphite black/Bentley brown
Product size: 1900*1560*1465 mm





ZS-04A T-BAR ROW

Color: Matte black
Seat cushion: Graphite black/Bentley brown
Product size: 1610*1560*1465 mm



ZS-04B SUPER ROWING CIRCULAR

Color: Matte black
Seat cushion: Graphite black/Bentley brown
Product size: 2210*1535*1465 mm



ZS-10 SUPER POWER ROW

Color: Matte black
Seat cushion: Graphite black/Bentley brown
Product size: 1590*1530*1770 mm



ZS-12 SUPER LAT MACHINE CONVERGENT

Color: Matte black
Seat cushion: Graphite black/Bentley brown
Product size: 2150*1530*2015 mm



ZS-06 ALTERNATE CURLING MACHINE

Color: Matte black
Seat cushion: Graphite black / Bentley brown
Product size: 1210*1710*1360 mm



ZS-07 FRENCH PRESS MACHINE

Color: Matte black
Seat cushion: Graphite black/Bentley brown
Product size: 2055*1515*1465 mm



ZS-12B SUPER LAT PULLDOWN CIRCULAR

Color: Matte black
Seat cushion: Graphite black/Bentley brown
Product size: 1660*1560*2180 mm



ZS-12C SUPER HIGH ROW

Color: Matte black
Seat cushion: Graphite black/Bentley brown
Product size: 2010*1530*2140 mm



ZS-08 FRONT DORSY BAR

Color: Matte black
Seat cushion: Graphite black/Bentley brown
Product size: 1550*1540*1465 mm



ZS-09 SUPER PULLOVER MACHINE

Color: Matte black
Seat cushion: Graphite black/Bentley brown
Product size: 2170*1540*1500 mm



ZS-13 SUPER PENDULUM SQUAT

Color: Matte black
Seat cushion: Graphite black/Bentley brown
Product size: 2130*1530*1780 mm



ZS-15A SUPER LEG PRESS 45°

Color: Matte black
Seat cushion: Graphite black/Bentley brown
Product size: 2620*1525*1530 mm



ZS-17 STANDING ABDUCTOR

Color: Matte black
Seat cushion: Graphite black/Bentley brown
Product size: 1900*1530*1465 mm



ZS-18 POWER SMITH DUAL SYSTEM UPPER

Color: Matte black
Seat cushion: Graphite black/Bentley brown
Product size: 1860*2030*1990 mm



ZS-19 POWER SMITH MACHINE DUAL SYSTEM

Color: Matte black
Seat cushion: Graphite black/Bentley brown
Product size: 1820 * 1930 * 1505 mm



ZS-20 VERTICAL LEG PRESS

Color: Matte black
Seat cushion: Graphite black/Bentley brown
Product size: 2100*2085*2090mm



ZS-21 HIP THRUST

Color: Matte black
Seat cushion: Graphite black/Bentley brown
Product size: 2220*1540*1535 mm

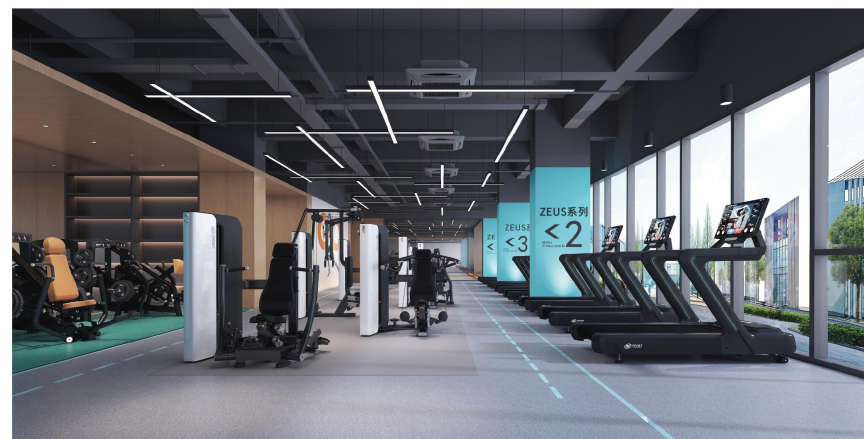
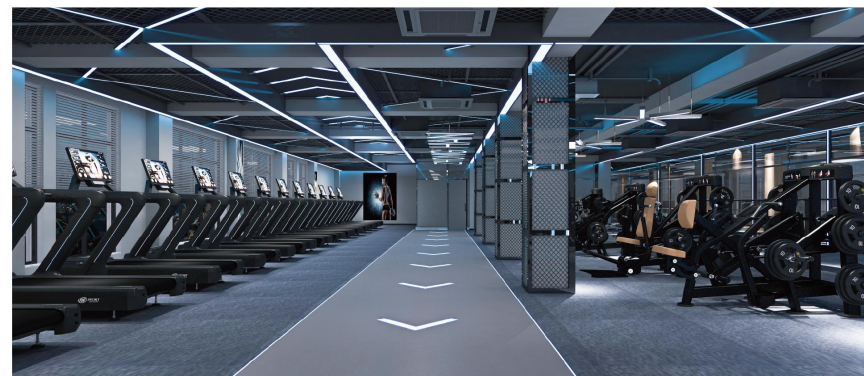
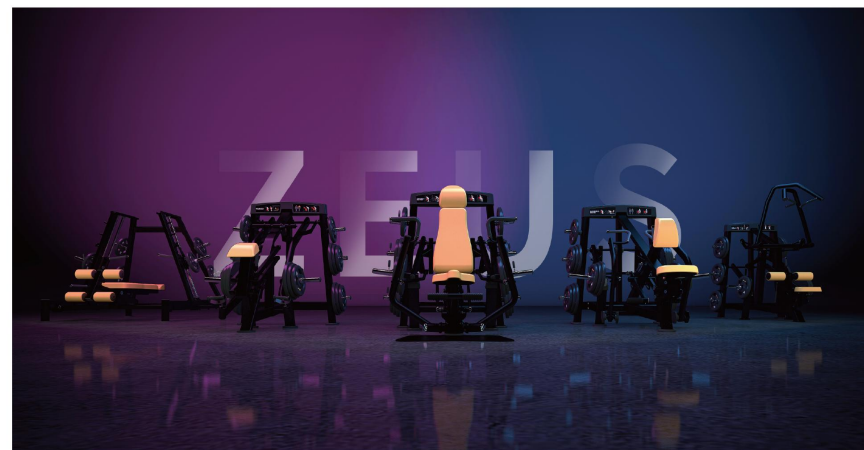

BE-SERIES

Black Eagle

A rugged style with sharp lines, delivering even better sports performance. The unique sense of weightiness always runs through JW's consistent aesthetic design concept, endowing the equipment with outstanding texture.



BE-001 Lateral Super Incline Chest Press

Boom color: matte black/sunset yellow/orange
 Seat and back cushion: graphite black
 Product weight: 308.65 lbs
 Dimension: 63 x 50 x 82 in



BE-002 Shoulder Press

Boom color: matte black/sunset yellow/orange
 Seat and back cushion: graphite black
 Product weight: 277.78 lbs
 Dimension: 75 x 63 x 67 in



BE-003 Lateral Kneeling Leg Curl

Boom color: matte black/sunset yellow/orange
 Seat and back cushion: graphite black
 Product weight: 238.1 lbs
 Dimension: 76 x 44 x 57 in



BE-004 Lateral Leg Press

Boom color: matte black/sunset yellow/orange
 Seat and back cushion: graphite black
 Product weight: 473.99 lbs
 Dimension: 83 x 77 x 59 in



BE-005 Seated Biceps

Boom color: matte black/sunset yellow/orange
 Seat and back cushion: graphite black
 Product weight: 220.46 lbs
 Dimension: 55 x 44 x 5 in



BE-006 Lateral Raise

Boom color: matte black/sunset yellow/orange
 Seat and back cushion: graphite black
 Product weight: 396.83 lbs
 Dimension: 57 x 50 x 53 in



BE-007 Lateral Low Row

Boom color: matte black/sunset yellow/orange
Seat and back cushion: graphite black
Product weight: 275.58 lbs
Dimension: 60 x 54 x 72 in



BE-008 Lateral Incline Chest Press

Boom color: matte black/sunset yellow/orange
Seat and back cushion: graphite black
Product weight: 286.6 lbs
Dimension: 65 x 46 x 79 in



BE-009 Barbell Rack

Boom color: matte black/shiny black
Product weight: 141.1 lbs
Dimension: 46 x 32 x 58 in



BE-010 Linear Leg Press

Boom color: matte black/sunset yellow/orange
Seat and back cushion: graphite black
Product weight: 429.9 lbs
Dimension: 89 x 54 x 61 in



BE-011 Weight Plate Rack

Boom color: matte black/shiny black
Product weight: 70.55 lbs
Dimension: 28 x 29 x 41 in



BE-012 V-Squat

Boom color: matte black/sunset yellow/orange
Seat and back cushion: graphite black
Product weight: 454.15 lbs
Dimension: 94 x 59 x 46 in

BLACK EAGLE



BE-012A Squat Calf Machine

Boom color: matte black/sunset yellow/orange
Seat and back cushion: graphite black
Dimension: 94 x 59 x 46 in



BE-014 Seated Row

Boom color: matte black/sunset yellow/orange
Seat and back cushion: graphite black
Product weight: 260.15 lbs
Dimension: 62 x 57 x 51 in



BE-015 Abdominal Oblique Crunch

Boom color: matte black/sunset yellow/orange
Seat and back cushion: graphite black
Product weight: 277.78 lbs
Dimension: 73 x 41 x 55 in



BE-016 Lateral Front Lat Pulldown

Boom color: matte black/sunset yellow/orange
Seat and back cushion: graphite black
Product weight: 313.06 lbs
Dimension: 72 x 59 x 81 in



BE-017 Push Shoulder Trainer

Boom color: matte black/sunset yellow/orange
Seat and back cushion: graphite black
Product weight: 301.59 lbs
Dimension: 71 x 54 x 77 in



BE-018 Reloaded Iso Flat Press

Boom color: matte black/sunset yellow/orange
Seat and back cushion: graphite black
Product weight: 204.59 lbs
Dimension: 73 x 69 x 45 in



BE-019 Seated Calf Machine

Boom color: matte black/sunset yellow/orange
Seat and back cushion: graphite black
Product weight: 116.84 lbs
Dimension: 48 x 28 x 37 in



BE-020 Arm Down Back Muscle Training

Boom color: matte black/sunset yellow/orange
Seat and back cushion: graphite black
Product weight: 340.39 lbs
Dimension: 70 x 61 x 52 in

BLACK



BE-025 Lateral Leg Extension

Boom color: matte black/sunset yellow/orange
Seat and back cushion: graphite black
Product weight: 263.45 lbs
Dimension: 77 x 45 x 41 in



BE-026 Seated Tricep Press

Boom color: matte black/sunset yellow/orange
Seat and back cushion: graphite black
Product weight: 261.03 lbs
Dimension: 74 x 65 x 41 in



BE-021 Utility Bench

Boom color: matte black/sunset yellow/orange
Seat and back cushion: graphite black
Product weight: 50.71 lbs
Dimension: 54 x 28 x 38 in



BE-022 Incline Pectoral Fly

Boom color: matte black/sunset yellow/orange
Seat and back cushion: graphite black
Product weight: 141.1 lbs
Dimension: 69 x 63 x 31 in



BE-027 Plate-Loaded Iso-Lateral Wide Pulldown

Boom color: matte black/sunset yellow/orange
Seat and back cushion: graphite black
Product weight: 309.09 lbs
Dimension: 71 x 45 x 79 in



BE-028 Chest Press & Lat Pulldown

Boom color: matte black/sunset yellow/orange
Seat and back cushion: graphite black
Product weight: 380.08 lbs
Dimension: 85 x 70 x 79 in



BE-023 Seated Leg Extension

Boom color: matte black/sunset yellow/orange
Seat and back cushion: graphite black
Product weight: 220.02 lbs
Dimension: 74 x 54 x 41 in



BE-024 Reloaded Vertical Leg Press

Boom color: matte black/sunset yellow/orange
Seat and back cushion: graphite black
Product weight: 453.71 lbs
Dimension: 67 x 62 x 79 in

FRAGILE



BE-029 Low Back Pull Trainer

Boom color: matte black/sunset yellow/orange
Seat and back cushion: graphite black
Product weight: 360.46 lbs
Dimension: 91 x 69 x 49 in



BE-030 Super Squat

Boom color: matte black/sunset yellow/orange
Seat and back cushion: graphite black
Product weight: 476.2 lbs
Dimension: 85 x 60 x 60 in



BE-031 Sitting Outer Thigh Abductor

Boom color: matte black/sunset yellow/orange
Seat and back cushion: graphite black
Product weight: 309.09 lbs
Dimension: 59 x 55 x 51 in



BE-032 Lateral Wild Chest

Boom color: matte black/sunset yellow/orange
Seat and back cushion: graphite black
Dimension: 88 x 45 x 69 in

BLACK



BE-37A Lateral Standing Lateral Raise

Boom color: matte black/sunset yellow/orange
Seat and back cushion: graphite black
Dimension: 47 x 44 x 53 in



BE-038 Iso Lateral Cross Lat Pulldown

Boom color: matte black/sunset yellow/orange
Seat and back cushion: graphite black
Dimension: 61 x 51 x 73 in



BE-033 Lateral Front Lat Pulldown

Boom color: matte black/sunset yellow/orange
Seat and back cushion: graphite black
Dimension: 65 x 48 x 82 in



BE-035 Lateral Decline Chest Press

Boom color: matte black/sunset yellow/orange
Seat and back cushion: graphite black
Dimension: 75 x 53 x 67 in

EAGLE



BE-040 Hip Thrust

Boom color: matte black/sunset yellow/orange
Seat and back cushion: graphite black
Dimension: 65 x 54 x 35 in



BE-041 T-Shaped Rowing Trainer

Boom color: matte black/sunset yellow/orange
Seat and back cushion: graphite black
Dimension: 75 x 36 x 46 in



BE-36A Belt Assisted Deep Squat

Boom color: matte black/sunset yellow/orange
Seat and back cushion: graphite black
Dimension: 96 x 61 x 60 in



BE-037 Standing Chest Trainers

Boom color: matte black/sunset yellow/orange
Seat and back cushion: graphite black
Dimension: 47 x 50 x 61 in



BE-042 Pendulum Squat

Boom color: matte black/sunset yellow/orange
Seat and back cushion: graphite black
Dimension: 73 x 45 x 57 in



BE-043 Standing Outer Thigh Abductor

Boom color: matte black/sunset yellow/orange
Seat and back cushion: graphite black
Dimension: 60 x 39 x 56 in



BE-045 Hack Squat

Boom color: matte black/sunset yellow/orange
Seat and back cushion: graphite black
Dimension: 89 x 75 x 47 in



BE-046 Linear Row

Boom color: matte black/sunset yellow/orange
Seat and back cushion: graphite black
Dimension: 55 x 79 x 45 in



BLACK EAGLE

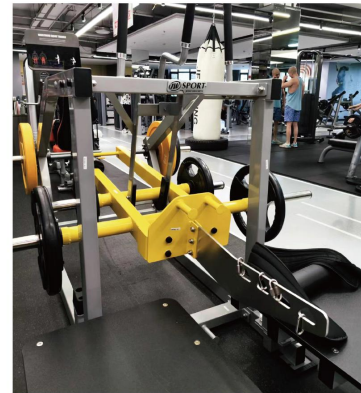

技术超越·智慧超越·服务超越·价值超越

XHA-SERIES

Free Weight Equipment

Almost infinite diversities provided by different multi-function training machines bring multiple accessories to fitness centres to make the best use of precious space as well as offer various users effective strength exercise options. Multiple configurations and accessory optional device are integrated to create limitless possibilities of workouts.



Eight Station LY-89
Size (mm): 6950*3550*2230 mm

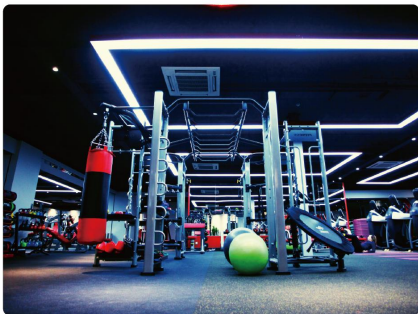



Glute Ham Developer XHA-002

Size (mm): 1425*845*1170 mm



Sissy Squat Bench XHA-003

Size (mm): 1915*650*420 mm



Hip Thrust XH-006

Size (mm): 1700*1380*860 mm



Hip Thrust XHA-006A

Size (mm): 1900*1600*770 mm



Hack Squat XHA-004

Size (mm): 1950*1765*1730 mm



Hack Squat XHA-04A

Size (mm): 2005*1765*1730 mm



Deadlift XHA-007

Size (mm): 1780*820*360 mm



Power Rack XHA-008

Size (mm): 3500*3100*2600mm(Contains Floor Glue)



Cable Crossover XHA-005

Size (mm): 3480*1270*2370 mm



Function Trainer XHA-05A

Size (mm): 1540*1200*2420 mm



Smith Machine XHA-020

Size (mm): 1570*2460*2390 mm



Smith Machine XHA-20A

Size (mm): 1960*2460*2490 mm



Squat Rack XHA-021

Size (mm): 1920*1630*2050 mm



Incline Leg Press (45°) XHA-022

Size (mm): 2375*1615*1470 mm



Decline Bench (luxury) XHA-024A

Size (mm): 1940*1615*1350 mm



Incline Bench (luxury) XHA-025

Size (mm): 1870*2000*1560 mm



Hack Squat Machine(45°) XHA-22A

Size (mm): 2520*975*1635 mm



Flat Chest Press Bench (Luxury) XHA-023

Size (mm): 1870*1670*1410 mm



Incline Bench (luxury) XHA-025A

Size (mm): 2320*1910*1575 mm



Vertical bench XHA-025B

Size (mm): 1770*1635*1835 mm



Weight Bench (Luxury) XHA-023A

Size (mm): 1700*1615*1350 mm



Decline Bench XHA-024

Size (mm): 1615*1815*1310 mm



Incline Bench (luxury) XHA-025C

Size (mm): 2070*1615*1510 mm



Roman Chair XHA-026

Size (mm): 1330*695*820 mm



Vertical Knee Raise XHA-027

Size (mm): 1190*1370*2355 mm



Web Board XHA-028

Size (mm): 1720*750*1055 mm



Abdominal Machine XHA-032

Size (mm): 1700*950*1010 mm



Stretching Machine XHA-033

Size (mm): 1340*675*945 mm



Seated calf machine XHA-029

Size (mm): 1260*750*790 mm



Dumbbell Rack XHA-030

Size (mm): 2710*960*835 mm



Adjustable Web Board XHA-034

Size (mm): 1965*745*945 mm



Flat Bench with Leg Attachment XHA-035

Size (mm): 1930*745*720 mm



Dumbbell Rack XHA-030B

Size (mm): 2290*1020*1040 mm



Dead Lift XHA-031

Size (mm): 1510*1600*790 mm



Flat Bench XHA-036

Size (mm): 1325*745*460 mm



Multi Adjustable Bench XHA-037

Size (mm): 1595*745*1150 mm



Utility Bench XHA-038

Size (mm): 1150*645*1100 mm



Barbell Rack XHA-039

Size (mm): 1240*785*1715 mm



Three Station PL-12

Size (mm): 3290x2380x2180 mm



Scott bench XHA-040

Size (mm): 1100*810*940 mm



Weight Plate Tree XHA-041

Size (mm): 745*675*940 mm

Four Station LY-49

Size (mm): 3290x2950x2180 mm



Standing Outer Thigh Abductor XHA-043

Size (mm): 1410*1270*1450 mm



Single Station PL-12A

Size (mm): 2010*960*2140 mm

Five Station LY-59

Size (mm): 5990*2250*2420 mm



TA-SERIES

Thalia Series

Thalia series, a high-end equipment designed for gluteal and leg muscle training, its streamlined line design with hot red, passion and elegance. The use of international cutting-edge dynamics technology, combined with cash ergonomic technology, after countless professional debugging, and finally create a variety of heights and training levels of users. Effectively toning the buttock muscles, helping to create perfect curves and create a confident posture.



Thalia

The brand-new fixed strength equipment of TA is majestic and sturdy, with a strong visual impact. Incorporates the cutting-edge design concepts of sports science. With its all-round outstanding features, it has become the highlight of the fitness space.

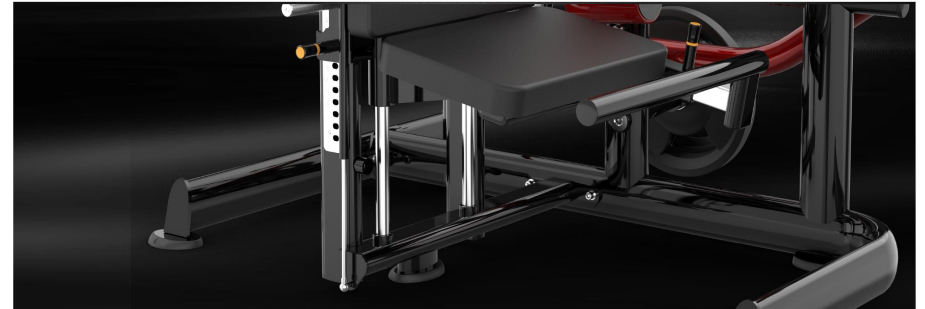



Dual 45 Hip Extension

TA-01

Productsize: 2050*1050*1370(mm)



Pendulum Kickback

TA-02

Productsize: 1800*1480*1450(mm)



Deadlift Elite

TA-06

Productsize: 1780*1910*750(mm)



Hip Thrust Elite

TA-03

Productsize: 1890*1820*1400(mm)



Kneeling Glute Isolator

TA-04

Productsize: 1680*1460*1460(mm)

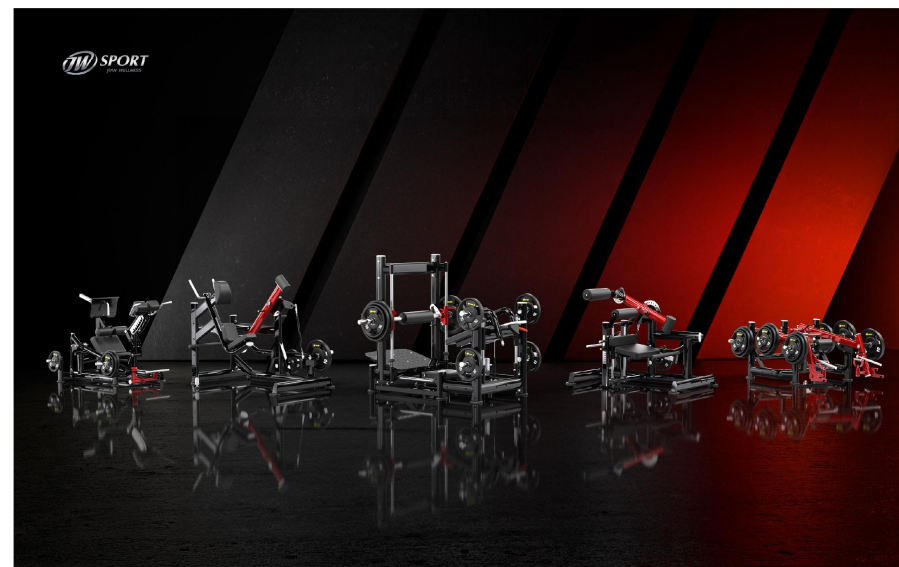

AS-SERIES

Ares Series

The Ares Series features a robust and steady design with sleek, flowing lines that provide a distinctive identity. Its design embodies a sense of powerful aesthetics, incorporating cutting-edge international biomechanics technology. With more scientifically optimized movement trajectories and core components benchmarked against European industrial standards, it ensures a seamless and smooth user experience with even force distribution.



Ares

The brand-new fixed strength equipment of AS is majestic and sturdy, with a strong visual impact. Incorporates the cutting-edge design concepts of sports science. With its all-round outstanding features, it has become the highlight of the fitness space.





SUPER VERTICAL CHEST PRESS AS-01A

Color: Bright red
 Seat cushion: Graphite black
 Product size: 2100*1800*1420(mm)



SUPER DELTOID SHOULDER PRESS AS-03

Color: Bright red
 Seat cushion: Graphite black
 Product size: 2230*1800*1390(mm)



SUPER INCLINED CHEST PRESS AS-03A

Color: Bright red
 Seat cushion: Graphite black
 Product size: 2050*1800*1830(mm)



SUPER ROWING AS-04

Color: Bright red
 Seat cushion: Graphite black
 Product size: 2090*1830*1390(mm)

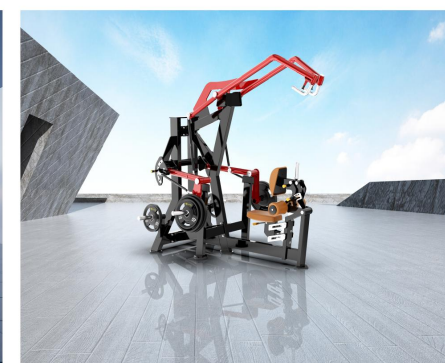



ARES SERIES



SUPER T BAR ROW

AS-04A

Color: Bright red
 Seat cushion: Graphite black
 Product size: 1900*1760*1525(mm)



SUPER ROWING CIRCULAR

AS-04B

Color: Bright red
 Seat cushion: Graphite black
 Product size: 2240*1820*1390(mm)



SUPER PULLOVER MACHINE

AS-09

Color: Bright red
 Seat cushion: Graphite black
 Product size: 2330*1900*1535(mm)



SUPER POWER ROW

AS-10

Color: Bright red
 Seat cushion: Graphite black
 Product size: 1800*1880*1880(mm)

ARES SERIES

Aggressive Aura, Overawing and Stunning
Igniting a Fanatical New Trend



ARES SERIES



SUPER LAT MACHINE CONVERGENT AS-12

Color: Bright red
Seat cushion: Graphite black
Product size: 2200*1840*2050(mm)



SUPER HIGH ROW AS-12C

Color: Bright red
Seat cushion: Graphite black
Product size: 2080*1850*2080(mm)



SUPER LEG PRESS 45° AS-15A

Color: Bright red
Seat cushion: Graphite black
Product size: 2620*1525*1530(mm)



POWER SMITH DUAL SYSTEM UPPER AS-18

Color: Bright red
Seat cushion: Graphite black
Product size: 1860*2030*1990(mm)



ARES SERIES

CREATE ANOTHER PEAK WORK. AS SUPER POWER

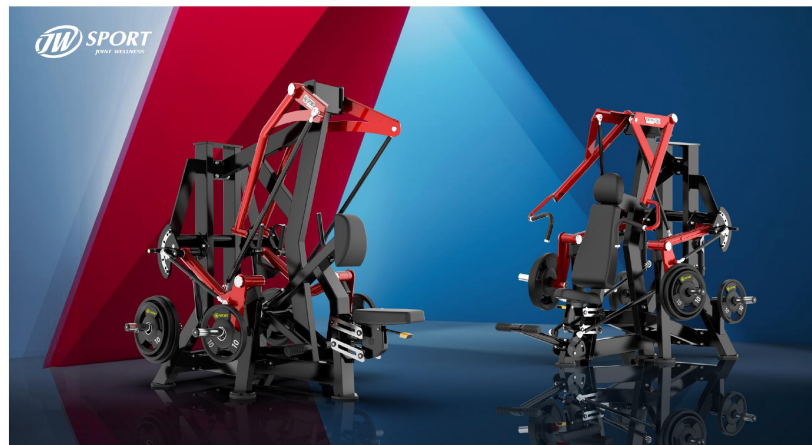

POWER SMITH MACHINE DUAL SYSTEM AS-19

Color: Bright red
Seat cushion: Graphite black
Product size: 1820*1930*1505(mm)



VERTICAL LEG PRESS AS-20

Color: Bright red
Seat cushion: Graphite black
Product size: 2100*2085*2090(mm)



ARES SERIES