

An ISO 9001 : 2015 Certified Co.



Locks & Hardware
Since 1954



**Elevating Everyday
Experiences**

www.metcraftchitra.com

w.e.f Aug. 2025

PRODUCT CATALOGUE & PRICE LIST

www.metcraftchitra.com



Locks & Hardware

Elevating Everyday Experience
Since 1952

"THE DETAIL ARE NOT THE DETAILS
THEY MAKE THE DESIGN"



Namastey

Chitra Enterprises is pleased to present their products under their brand name 

A Premium & Architectural range of Brass Builder's Hardware are designed to give an exclusive and royal look to your dream homes. The dazzling, sparking and mesmerizing range has been designed to blend with the modern exterior and interior, at the same time enhancing the beauty of its environment , Every piece goes through stringent quality control measures to assure consistent production standards from one batch to another.

Quality product at reasonable prices is the sure motto of our company. The company has a very strong technical base with super skilled man power, supervision under the guidance of experienced staff, so as to get optimum productivity from man, material and machines.

We most cordially welcome you to the house of  to match your choice & compare the difference



We offer a comprehensive range of INDIA manufactured products, all of which are made by highly experienced workforce.

Technical expertise in various Product Categories



Pull Handle

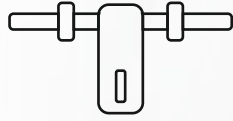

Aldrop



Door
Knocker



Tower
Bolt



Door
Stopper

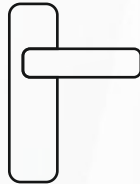

Mortise Handles
on Plate



Mortise Handles
on Rose

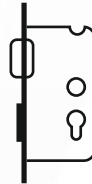

Mortise
Lock



Pin Cylinder



Door Lock

PRODUCT QUALITY TEST



PENCIL HARDNESS TEST:
passed scratch test of
graphite pencils 4h



SALT SPRAY TEST:
passed ASTM B117
salt spray fog test and
salt spray corrosion
test +96hr



ACITON TEST:
Passed aciton test
min +1500 rubbing
test passed



Cass test passed for
accelerated corrosion test
for verify protective
properties of nickle
and chrome plated parts



SWEAT CYCLE TEST:
show a light chloride
level less then or equal
to 29mmol/L=CK





OUR GLOBAL NETWORK



SOUTH AFRICA



UAE



GERMANY



U.K.



NEPAL



BANGLADESH



BHUTAN



SRI LANKA



OUR DOMESTIC NETWORK

visit us at:
www.metcraftchitra.com

feedback & reviews:
enterprises.chitra@gmail.com



Locks & Hardware

Elevating Everyday Experience
Since 1952

Certificate of Approval Environmental Management System

This is to certify that the Environmental Management System

at

CHITRA ENTERPRISES

Aligarh-202001 (U.P.) INDIA

has been examined by Assessors of
QMS Certification Services Pvt. Ltd.
and found to be conforming to the requirements of

ISO 14001:2015

in respect of the following activities

Manufacturer, Exporter, Importer & Supplier of Locks
and Builder Hardware

Current Issue Date 25/9/2023, Valid till 3/9/2026
Original Certification 03/9/2016



Carl Blank
Carl Blank,
Director, Technical
Operations & Business Units,
NSF-ISR, Ltd.

Certificate of Approval Quality Management System

This is to certify that the Environmental Management System

at

CHITRA ENTERPRISES

Aligarh-202001 (U.P.) INDIA

has been examined by Assessors of
QMS Certification Services Pvt. Ltd.
and found to be conforming to the requirements of

ISO 14001:2015

in respect of the following activities

Manufacturer, Exporter, Importer & Supplier of Locks
and Builder Hardware

Current Issue Date 25/9/2023, Valid till 3/9/2026
Original Certification 03/9/2016



Carl Blank
Carl Blank,
Director, Technical
Operations & Business Units,
NSF-ISR, Ltd.

OUR

Certification

Standards we follow



Handicap
Accessible



Fire Doors
Hardware



Mechanical
Guarantee



Technical
Guarantee



BS EN 1906



BS EN 1935



BS EN 12209



BS EN 1154



BS EN 1303



BS EN 1125

made of **solid
brass**

**EXCELLENT QUALITY
IN INDIA**

Salient Features

Hardware is not only the jewellery of a home. Also it is the crowning glory of your beautiful doors, windows and the final detail in furnishing your home. A stunning & unique entry door set or bedroom door set from Hardware.

Chitra not only adorns your fine home but ensure productivity, security along with elegance, which last long. That is the true value of buying high end hardware. A fascinating aspect of hardware is that in the most elegant of homes, the only thing you ever really touch is the hardware, making it a vitally important choice. Superior craftsmanship and finishes, timeless design and precision engineering, will serve you well and enhance your home's value for years to come.

Chitra has made extraordinary hardware for small and large projects : Luxury villas and estates, high end boutique, hotels and winning resorts. Chitra's vision stemmed from the idea of introducing the West to the exceptional work of Indian artisans. It maintained a striking balance between the two different worlds and this was integral to the success of this venture, original designs, unexpected finishes, the best quality materials and precision engineering. The company has added sustainable design and production, caring for the environment.

Finish and Precision is what sets Chitra apart, so much so that our customers now expect the unexpected from the company. The company's USP is exceptional finish and precision working.

You will not find any other hardware like it in the world. That offer extraordinary product ranges, each with its own unique features.

Team Chitra Enterprises

MODERN SIMPLE LIFE & **design**

Due to our excellent designer team, who aim at researching and designing products. Chitra have launched over 10 new designs which are attractive and can meet the need of market. What is important is that we apply for patent on our designs to make sure they are unique and competitive.



Mukesh Pradhan
Product Designer, R&D

Product Design must reflect the soul of the brand. That is an idea of simple and pure to serve in a daily life.



Ramesh Chandra
3D, Space Designer

Look to the past to design the present with ideas that peer into the future", this is the design philosophy, a designer who when developing a design, associate the demand of the future market.



Priyanka Jain
Online Promotion & Branding

Process fo using the internet world wide various platform to promote our brand. It is essential if you want to get brand exposure at a reasonable cost.

visit us at:
www.metcraftchitra.com

feedback & reviews:
enterprises.chitra@gmail.com



Locks & Hardware

Elevating Everyday Experience

Since 1952

OUR EXHIBITION



HBLF SHOW
AHMEDABAD, INDIA
December 2018



INDEX
NEW DELHI, INDIA
August 2019



FIT TECH EXHIBITION,
BERMINGHAM, UK
February 2019



INDEX
Guwahati Exhibition
2022



HBLF SHOW
AHMEDABAD, INDIA
2022

WHAT'S INSIDE





Locks & Hardware

Elevating Everyday Experience

Since 1952

index

Brass Articles	01-10
Pull Handles	11-23
Zinc Mortice Handles	24-32
Aluminium Rose Handles	33
Stainless Steel Mortice Handles	34-39
Iron Mortice Handles	40-42
Zinc Baby Latch	40-42
Lockbodies & Cylinders	44-45
Brass Door Kits	46-62
Zinc Door Kits	63-70
Stainless Steel Door Kits	71-75
Brass Cabinet Handles & Knobs	76-78
Wardrobe & Sliding Handles & S.S. Knobs	79-82
Stopper, Door Eye & Numeric	83-84
Tower Bolt & Latches	85-88
Door Locks	89
Cupboard & Multipurpose Locks	90-91
Hanger & Towel Holder	92



Locks & Hardware

BRASS
WALL HANGING

brass articles

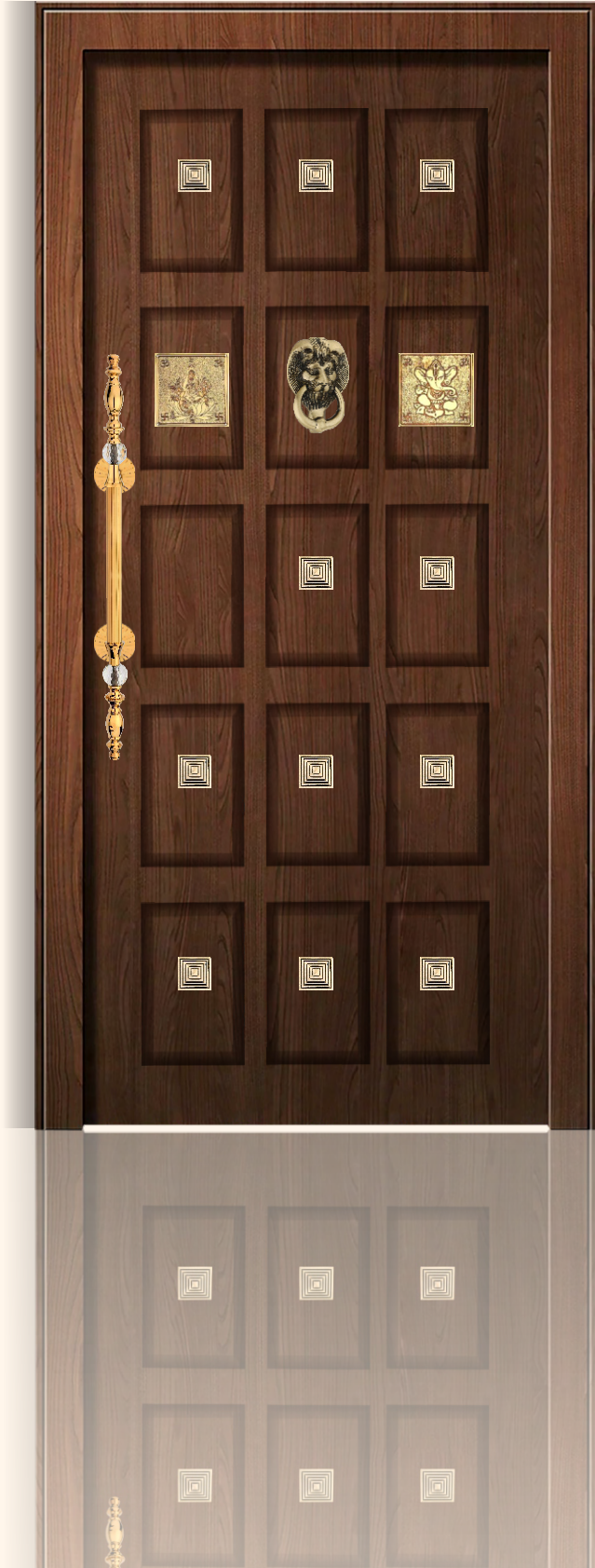



Laxmi & Ganpati ji

Material: Brass
Finish: ABM
Description: Wall Hanging

Size	Packing/Box	MRP/Pc
150x100mm	2 Pc.	2800/-



Tirupati Balaji

Material: Brass
Finish: ABM
Description: Wall Hanging

Size	Packing/Box	MRP/Pc
160x165mm	2 Pc.	2070/-



Kamal Laxmi ji

Material: Brass
Finish: ABM
Description: Wall Hanging

Size	Packing/Box	MRP/Pc
182x172mm	2 Pc.	2240/-



Kamal Ganesh ji

Material: Brass
Finish: ABM
Description: Wall Hanging

Size	Packing/Box	MRP/Pc
185x172mm	2 Pc.	2580/-





BDK - 01 Lion

Finish: ABM

Size	Packing/Box	MRP/Pc
100mm	1 Pc.	1710/-



BDK - 02 Gulf Flower

Finish: ABM

Size	Packing/Box	MRP/Pc
150mm	1 Pc.	2010/-



BDK - 03 Mayura

Finish: ABM

Size	Packing/Box	MRP/Pc
100mm	1 Pc.	3070/-



BDK - 05 Tiger

Finish: ABM

Size	Packing/Box	MRP/Pc
100mm	1 Pc.	4070/-



BDK - 06 Liberty

Finish: ABM

Size	Packing/Box	MRP/Pc
150mm	1 Pc.	4010/-



BDK - 08 Ganesha

Finish: ABM

Size	Packing/Box	MRP/Pc
100mm	1 Pc.	2480/-



BDK - 09 Shield

Finish: ABM/ACM

Size	Packing/Box	MRP/Pc
100mm	1 Pc.	472/-



BDK - 10 Grip

Finish: ABM

Size	Packing/Box	MRP/Pc
150mm	1 Pc.	649/-



BDK - 11 Ring

Finish: ABM

Size	Packing/Box	MRP/Pc
100mm	1 Pc.	549/-





Locks & Hardware

BRASS DOOR DOMES



BD-01 Flower

Finish: AB

Size	Packing/Box	MRP/Pc
50mm	24 Pc.	156/-
62mm	20 Pc.	197/-
75mm	12 Pc.	296/-



BD-12 Ashoka

Finish: AB

Size	Packing/Box	MRP/Pc
50mm	24 Pc.	190/-
62mm	20 Pc.	258/-
75mm	12 Pc.	386/-



BD-13 - Wheel

Finish: Coffee

Size	Packing/Box	MRP/Pc
62mm	20 Pc.	179/-



BD-06 Gama

Finish: AB/MAB

Size	Packing/Box	MRP/Pc
50mm	24 Pc.	194/-
62mm	20 Pc.	271/-
75mm	12 Pc.	401/-



BD-18 Sunflower

Finish: AB

Size	Packing/Box	MRP/Pc
50mm	24 Pc.	179/-
65mm	20 Pc.	260/-
85mm	12 Pc.	533/-



BD-03 Vezel

Finish: AB/MAB

Size	Packing/Box	MRP/Pc
50mm	24 Pc.	269/-
62mm	20 Pc.	358/-
75mm	12 Pc.	529/-
125mm	5 Pc.	1848/-

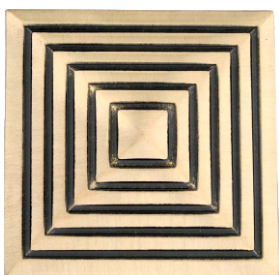

BD-15 Pyramid

Finish: AB/Coffee

Size	Packing/Box	MRP/Pc
62mm	20 Pc.	179/-



BD-19 Armor

Finish: AB/MAB

Size	Packing/Box	MRP/Pc
65mm	20 Pc.	231/-

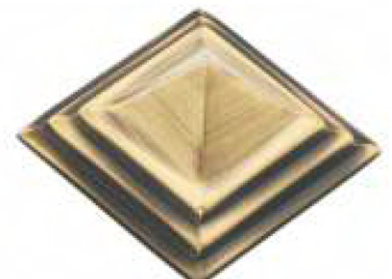

BD-20 Doma

Finish: AB

Size	Packing/Box	MRP/Pc
50mm	24 Pc.	165/-
75mm	12 Pc.	330/-





BDF 11-TILAK

Finish: Coffee

MRP/Pc	1294/-
--------	--------



BDF 12-CHAKRA

Finish: Coffee

MRP/Pc	1424/-
--------	--------



BDF 13-SHANKH

Finish: Coffee

MRP/Pc	1424/-
--------	--------



BDF 14-KHANDA

Finish: Coffee

Size	MRP/Pc
85X120mm	466/-



BDF 15

Finish: Coffee

Size	MRP/Pc
50X50 mm	212/-
75X75 mm	486/-
100X100 mm	788/-



BDF 16

Finish: Coffee

Size	MRP/Pc
50X50 mm	212/-
75X75 mm	486/-
100X100 mm	788/-



BDF 17

Finish: Coffee

Size	MRP/Pc
65X65 mm	335/-



BDC 01

Finish: Coffee

Size	MRP/Pc
70X70 mm	184/-
100X100 mm	396/-



BDF 18-VANAKKAM

Finish: Coffee

Size	MRP/Pc
125X90 mm	929/-



BDF 19-TAMIL WELCOM

Finish: Coffee

Size	MRP/Pc
125X50 mm	571/-



BDF 01-OM

Finish: Coffee

Size	MRP/Pc
75X75mm	466/-
100X100mm	803/-
150X105mm	2304/-



BDF 02-GANPATI JI

Finish: Coffee

Size	MRP/Pc
75X75mm	517/-
100X100mm	803/-
150X105mm	2535/-

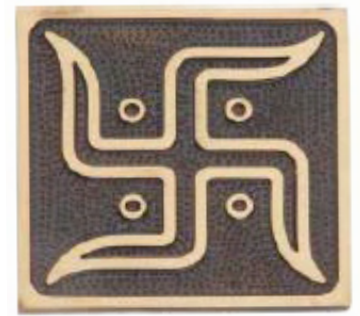

BDF 03-SWASTIK

Finish: Coffee

Size	MRP/Pc
75X75mm	466/-
100X100mm	803/-
150X105mm	2304/-



BDF 04 AHINSA

Finish: Coffee

Size	MRP/Pc
25X125mm	466/-



BDF 05-KHATUSHYAM JI

Finish: Coffee

Size	MRP/Pc
175X85mm	1604/-



BDF 06-LADDU GOPAL

Finish: Coffee

Size	MRP/Pc
100X100mm	810/-
150X150mm	1807/-



BDF 07-KALASH

Finish: Coffee

Size	MRP/Pc
100X100mm	855/-
150X150mm	2328/-



BDF 08-TAMIL OM

Finish: Coffee

Size	MRP/Pc
90X100mm	828/-



BDF 09-786

Finish: Coffee

Size	MRP/Pc
100X75mm	700/-
125X100mm	936/-



BDF 10-SHRI KRISHNA

Finish: Coffee

Size	MRP/Pc
85X125mm	1087/-





BDS 01-OM

Finish: ABM

Size	Packing/Box	MRP/Pc
100X100mm	1 Pc.	892/-
150X150mm	1 Pc.	1979/-
200X200mm	1 Pc.	3511/-



BDS 02-GANPATI

Finish: ABM

Size	Packing/Box	MRP/Pc
100X100mm	1 Pc.	892/-
150X150mm	1 Pc.	1979/-
200X200mm	1 Pc.	3511/-



BDS 03-LAXMI

Finish: ABM

Size	Packing/Box	MRP/Pc
100X100mm	1 Pc.	892/-
150X150mm	1 Pc.	1979/-
200X200mm	1 Pc.	3511/-

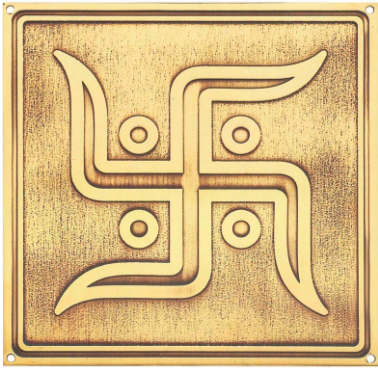

BDS 04-SWASTIK

Finish: ABM

Size	Packing/Box	MRP/Pc
100X100mm	1 Pc.	892/-
150X150mm	1 Pc.	1979/-
200X200mm	1 Pc.	3511/-



BDS 05-KALASH

Finish: ABM

Size	Packing/Box	MRP/Pc
100X100mm	1 Pc.	907/-
150X150mm	1 Pc.	1979/-
200X200mm	1 Pc.	3511/-



BDS 06-SHUBH LABH

Finish: ABM

Size	Packing/Box	MRP/Pc
100X50mm	1 Pc.	774/-



BDS 07-TIRUPATI TILAK

Finish: ABM

Size	Packing/Box	MRP/Pc
300X115mm	1 Pc.	1981/-
600X115mm	1 Pc.	5211/-





BDS 08

Finish: ABM

Size	Packing/Box	MRP/Pc
100X100mm	1 Pc.	810/-
150X150mm	1 Pc.	1807/-

BDS 09

Finish: ABM

Size	Packing/Box	MRP/Pc
38X600mm	1 Pc.	1745/-
50X600mm	1 Pc.	2305/-

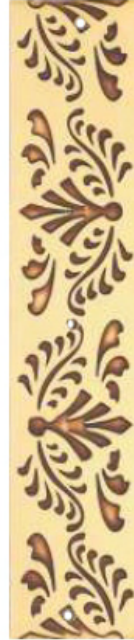

BDS 10

Finish: ABM

Size	Packing/Box	MRP/Pc
100X100mm	1 Pc.	810/-

BDS 11

Finish: ABM

Size	Packing/Box	MRP/Pc
30X600mm	1 Pc.	1488/-

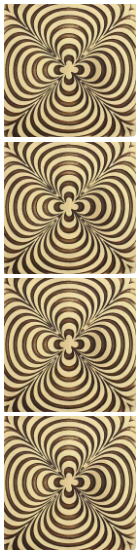

BDS 12

Finish: ABM

Size	Packing/Box	MRP.
100X100mm	1 Pc.	810/-
150X150mm	1 Pc.	1807/-

BDS 13

Finish: ABM

Size	Packing/Box	MRP/Pc
38X600mm	1 Pc.	1745/-
50X600mm	1 Pc.	2305/-
75X600mm	1 Pc.	3364/-



BDS 14

Finish: ABM

Size	Packing/Box	MRP.
100X100mm	1 Pc.	699/-

BDS 15

Finish: ABM

Size	Packing/Box	MRP/Pc
30X600mm	1 Pc.	1488/-



BDS 16

Finish: ABM

Size	Packing/Box	MRP/Pc
50X400X5mm	1 Pc.	2577/-



BDS 18

Finish: ABM

Size	Packing/Box	MRP/Pc
50X400X5mm	1 Pc.	2577/-





Locks & Hardware

**BRASS
DECORATIVE BELLS**

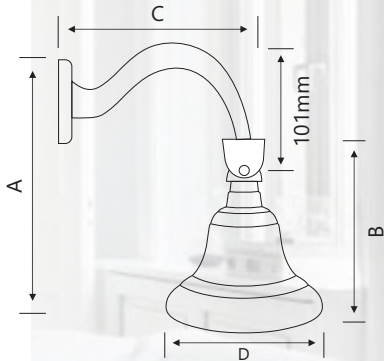

BHB - 01 Venice

Material: Brass
Finish: AB
Description: Bell

A	B	C	D	Packing/Box	MRP
185mm	110mm	95mm	105mm	1 Pc.	2352/-

Brass Bells

With Chain

Bell Size: 2"/50mm

Chain Length: 300mm



Design	MRP/Set	
	AB/AM/BPL	FG/RG/SG
Designer	295/-	317/-
Maxican	371/-	401/-
Italian	406/-	440/-
Russian	394/-	428/-
Classic	365/-	392/-



BDB - 01 Designer

Material: Brass
Finish: AB/SG/AM/RG/FG
Description: Bell

Size	Packing/Box	MRP/Pc	
		AB/AM	RG / SG / FG
25mm	48 Pc.	88/-	97/-
38mm	24 Pc.	112/-	123/-
50mm	12 Pc.	169/-	185/-



RG

SG

AM

AB

BDB - 02 Maxican

Material: Brass
Finish: AB/AM/SG/RG/FG
Description: Bell

Size	Packing/Box	MRP/Pc	
		AB/AM	RG/SG/FG
25mm	48 Pc.	111/-	122/-
38mm	24 Pc.	170/-	187/-
50mm	12 Pc.	245/-	269/-



RG

SG

AM

AB

BDB - 03 Italian

Material: Brass
Finish: AB/AM/SG/RG/FG
Description: Bell

Size	Packing/Box	MRP/Pc	
		AB/AM	RG/SG/FG
25mm	48 Pc.	146/-	160/-
38mm	24 Pc.	213/-	234/-
50mm	12 Pc.	281/-	308/-



RG

SG

AM

AB

BDB - 04 Russian

Material: Brass
Finish: AB/AM/SG/RG/FG
Description: Bell

Size	Packing/Box	MRP/Pc	
		AB/AM	RG/SG
25mm	48 Pc.	121/-	133/-
38mm	24 Pc.	159/-	175/-
50mm	12 Pc.	269/-	296/-



RG

SG

AM

AB

BDB - 05 Classic

Material: Brass
Finish: AB/AM/SG/RG/FG
Description: Bell

Size	Packing/Box	MRP/Pc	
		AB/AM	RG/SG/FG
25mm	48 Pc.	113/-	122/-
38mm	24 Pc.	161/-	175/-
50mm	12 Pc.	240/-	260/-



RG

SG

AM

AB





Locks & Hardware



pull
Handles



BPLR 16 Romane

Material: Brass
Finish: ABM
Description:
Pull Handle Use for Glass & Wooden Doors

A (mm/Inch)	B (mm)	C (mm)	Packing/ Box	MRP/Pc ABM
240/10	20	250	1 Pair	1620/-

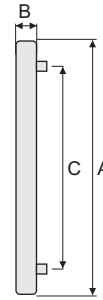

BPLR 18 Eco

Material: Brass
Finish: ABM
Description:
Pull Handle Use for Glass & Wooden Doors

A (mm/Inch)	B (mm)	C (mm)	Packing/ Box	MRP/Pc ABM
240/10	20	250	1 Pair	1620/-

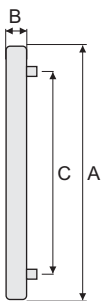

BPL 37 Scarlett

Material: Brass
Finish: ABM
Description:
Pull Handle Use for Glass & Wooden Doors

A (mm/Inch)	B (mm)	C (mm)	Packing/ Box	MRP/Pc ABM
300/12	20	250	2 Pc.	2360/-

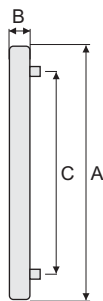

BPL 36 Taylor

Material: Brass
Finish: ABM
Description:
Pull Handle Use for Glass & Wooden Doors

A (mm/Inch)	B (mm)	C (mm)	Packing/ Box	MRP/Pc ABM
300/12	20	250	2 Pc.	2360/-



BPL 81 Ganesh Ji

Material: Brass
Finish: AB, BGC
Description:
Pull Handle Use for Glass & Wooden Doors

A (mm/Inch)	B (mm)	C (mm)	Packing/ Box	MRP/Pc AB/BGC
300/12	20	250	2 Pc.	2300/-





Locks & Hardware

ZINC

PULL HANDLES ON ROSE



ZPLR 21 - Alaska

Material: White Metal
Finish: NSM / ABM
Description:
Pull Handle on Rose



A (mm/Inch)	B (mm)	C (mm)	Rod Dia (mm)	Packing/ Box	MRP/Pc
300/12	50	250	-	1 Pair.	1490/-



ZPLR 22 - Florida

Material: White Metal
Finish: NSM / ABM
Description:
Pull Handle on Rose



A (mm/Inch)	B (mm)	C (mm)	Rod Dia (mm)	Packing/ Box	MRP/Pc
270/11	50	220	-	1 Pair.	1490/-





Locks & Hardware

SS 304 PULL HANDLES

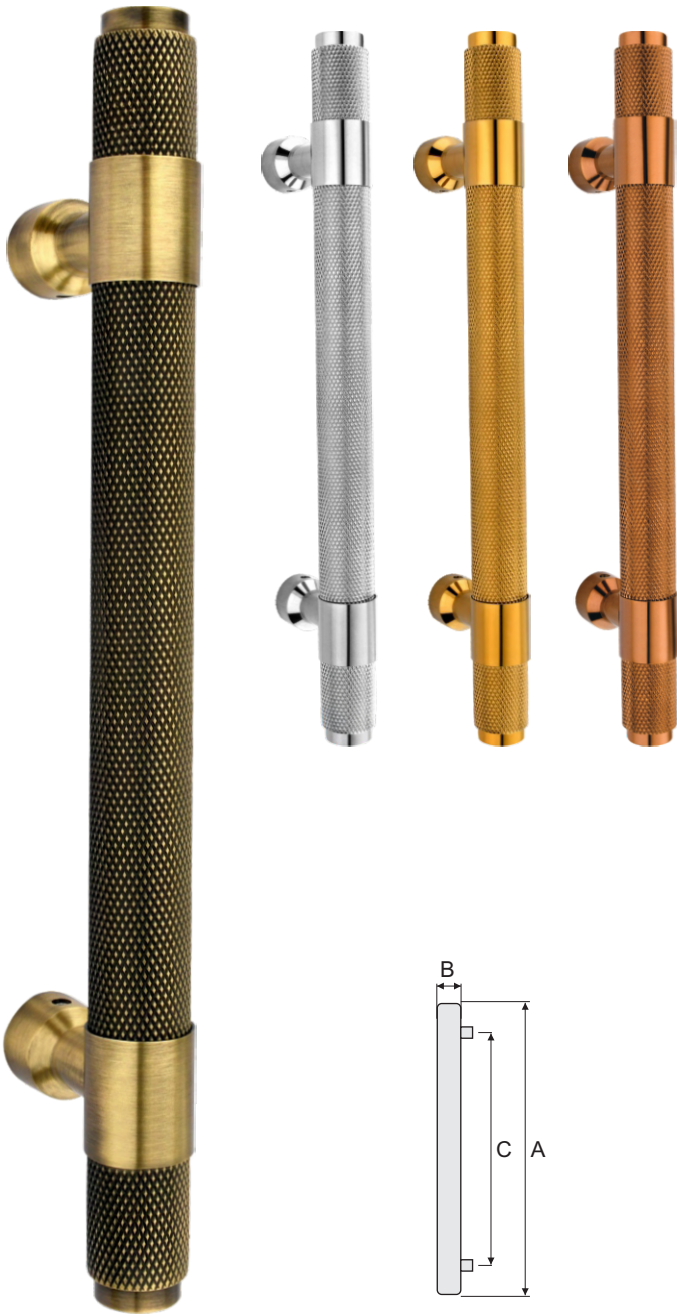

SPL-13- Nord

Material: SS304
Finish: SS / AB / PVD RG / FG
Description: Pull Handle Use for Glass & Wooden Doors

A (mm/Inch)	B (mm)	C (mm)	Rod Dia (mm)	Packing/ Box	MRP/Pc	
					SS/AB	PVD RG/FG
300/12	26	200	25	2 Pc.	2550/-	2970/-
450/18	26	300	25	2 Pc.	3820/-	4460/-
600/24	26	400	25	2 Pc	5100/-	5950/-



SPL 07 - VIZIER

Material: SS 304
Finish: SS / AB / PVD RG / FG
Description: Pull Handle Use for Glass & Wooden Doors

A (mm/Inch)	C (mm)	Rod Dia (mm)	Packing/ Box	MRP/Pc	
				AB/SS	PVD RG/FG
385/15	200	25	1 Pc.	1420/-	1710/-
560/22	300	32	1 Pc.	3540/-	4480/-





SPL 09 - Mor Pankh

Material: SS 304

Finish: SS / ABM / BM

Description: Pull Handle Use for Glass & Wooden Doors

A (mm/Inch)	B (mm)	C (mm)	Packing/Box	MRP/Pc
300/12	40	260	4 Pc.	1240/-
450/18	40	405	4 Pc.	1860/-



SPL 14 - Flame

Material: SS 304

Finish: SS / ABM / BM

Description: Pull Handle Use for Glass & Wooden Doors

A (mm/Inch)	B (mm)	C (mm)	Packing/Box	MRP/Pc
300/12	40	260	4 Pc.	1240/-
450/18	40	405	4 Pc.	1860/-



Locks & Hardware

SS 304 PULL HANDLES



SPL 15 - Tuff

Material: SS 304

Finish: SS / ABM / BM

Description: Pull Handle Use for Glass & Wooden Doors

A (mm/Inch)	B (mm)	C (mm)	Packing/Box	MRP/Pc
300/12	40	260	4 Pc.	1850/-



SPL 16 - Vessel

Material: SS 304

Finish: SS / ABM / BM

Description: Pull Handle Use for Glass & Wooden Doors

A (mm/Inch)	B (mm)	C (mm)	Packing/Box	MRP/Pc
300/12	40	260	4 Pc.	1240/-
450/18	40	405	4 Pc.	1860/-





SPL 06 - BLOXX

Material: SS 304

Finish: Textured Glass

Description:

Pull Handle Use for Glass & Wooden Doors

A (mm/Inch)	B (mm)	C (mm)	Packing/Box	MRP / PC
380/15	50	300	2 Pc	4250/-
500/20	50	450	2 Pc	5430/-
650/27	50	600	2 Pc	6370/-



APL 04 - MARCUS

Material: Aluminim

Finish: RG, RGB

Description:

Pull Handle Use for Glass & Wooden Doors

Center to Center (C-C)	Length	Rod Dia	MRP / PC
200	16/400	25	4960/-
300	20/500	25	5660/-
300	26/650	25	6490/-

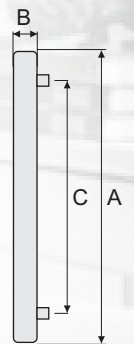

APL 03 - SQUARE

Material: Aluminim

Finish: Satin Silver

Description:

Pull Handle Use for Glass & Wooden Doors

A (mm/Inch)	B (mm)	C (mm)	Packing/Box	MRP / PC
270/11	25	200	2 Pc.	1300/-
370/15	25	300	2 Pc.	1650/-
470/19	25	400	2 Pc.	2010/-
570/23	25	500	2 Pc.	2360/-





Locks & Hardware

SS 304

PULL HANDLES

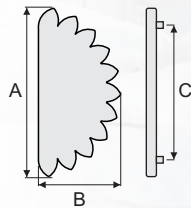
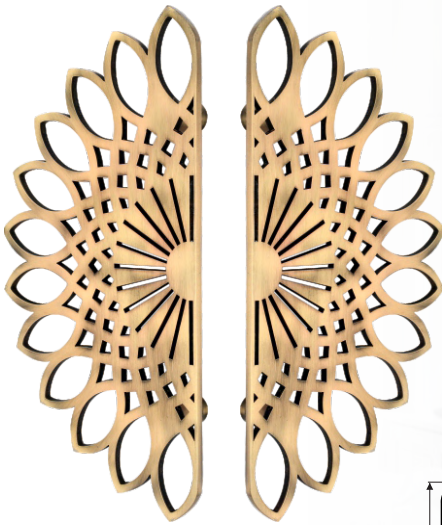

SPL 01 Shine

Material: SS 304
 Finish: ABM / PTAB
 Description: SS304

A (mm/Inch)	B (mm)	C (mm)	Packing/ Box	MRP/Pair	
				ABM	PTAB
150/6	75	80	1 Pair	2120/-	2360/-
300/12	150	180	1 Pair	5310/-	5660/-

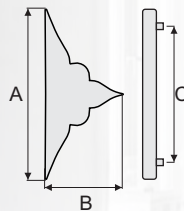
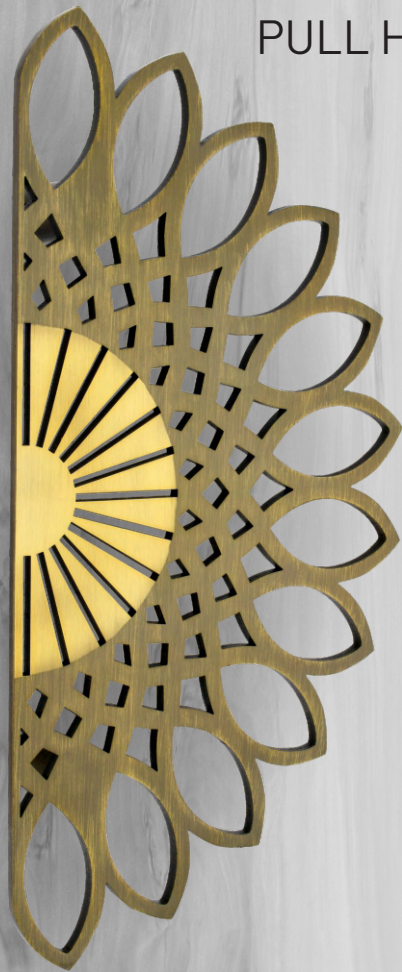

SPL 02 Twilight

Material: SS 304
 Finish: ABM / PTAB
 Description: SS304

A (mm/Inch)	B (mm)	C (mm)	Packing/ Box	MRP/Pair	
				ABM	PTAB
175/7	93	120	1 Pair	2120/-	2360/-
300/12	150	180	1 Pair	5310/-	5660/-





Locks & Hardware

SS 304

PULL HANDLES



**SPL 03
Nature**

Material: SS304
Finish: ABM / PTAB
Description:
SS 304 Pull Handle

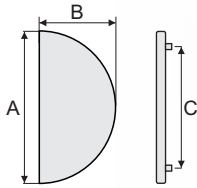

A (mm/Inch)	B (mm)	C (mm)	Packing/ Box	MRP/Pair	
				ABM	PTAB
150/6	75	125	1 Pair	2120/-	2360/-
300/12	150	180	1 Pair	5310/-	5660/-

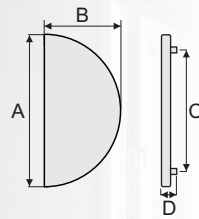

SPL 04 Camila

Material: SS304
Finish: AB / PTAB
Description: SS 304 Pull Handle

A (mm/Inch)	B (mm)	C (mm)	Packing/ Box	MRP/Pair	
				ABM	PTAB
150/6	75	125	1 Pair	2120/-	2360/-
300/12	150	180	1 Pair	5310/-	5660/-





Locks & Hardware

SS 304

PULL HANDLES



**SPL 10
Peacock**

Material: SS304

Finish: PTAB

Description:

SS 304 Pull Handle



A (mm/Inch)	B (mm)	C (mm)	Packing/ Box	MRP / PAIR
300/12	111	275	1 Pair.	3540/-



SPL 08 - Armani

Material: SS304

Finish: PTAB

Description: SS 304 Pull Handle



A (mm/Inch)	B (mm)	C (mm)	Packing/ Box	MRP/Pair
300/12	105	180	1 Pair.	3540/-



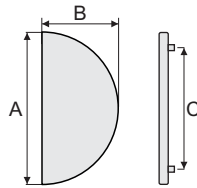

**SPL 17
Swastik**

Material: SS304
Finish: ABM
Description:
SS 304 Pull Handle

A (mm/Inch)	B (mm)	C (mm)	Packing/ Box	MRP/Pair
300/12	150	180	1 Pair.	5310/-

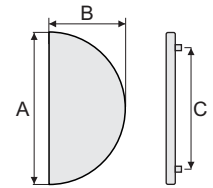

**SPL 18
Ganesh Ji**

Material: SS304
Finish: ABM
Description:
SS 304 Pull Handle

A (mm/Inch)	B (mm)	C (mm)	Packing/ Box	MRP/Pair
300/12	150	180	1 Pair.	5310/-

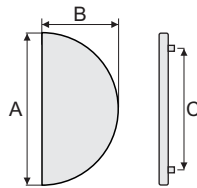

**SPL 19
Shubh-Labh**

Material: SS304
Finish: ABM
Description:
SS 304 Pull Handle

A (mm/Inch)	B (mm)	C (mm)	Packing/ Box	MRP/Pair
300/12	150	180	1 Pair.	5310/-

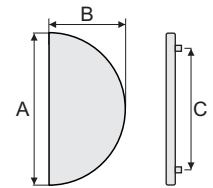

**SPL 20
SPADE**

Material: SS304
Finish: ABM
Description:
SS 304 Pull Handle

A (mm/Inch)	B (mm)	C (mm)	Packing/ Box	MRP/Pair
300/12	150	180	1 Pair.	5310/-





Locks & Hardware

SS 304
PULL HANDLES
with Tri-Bolt

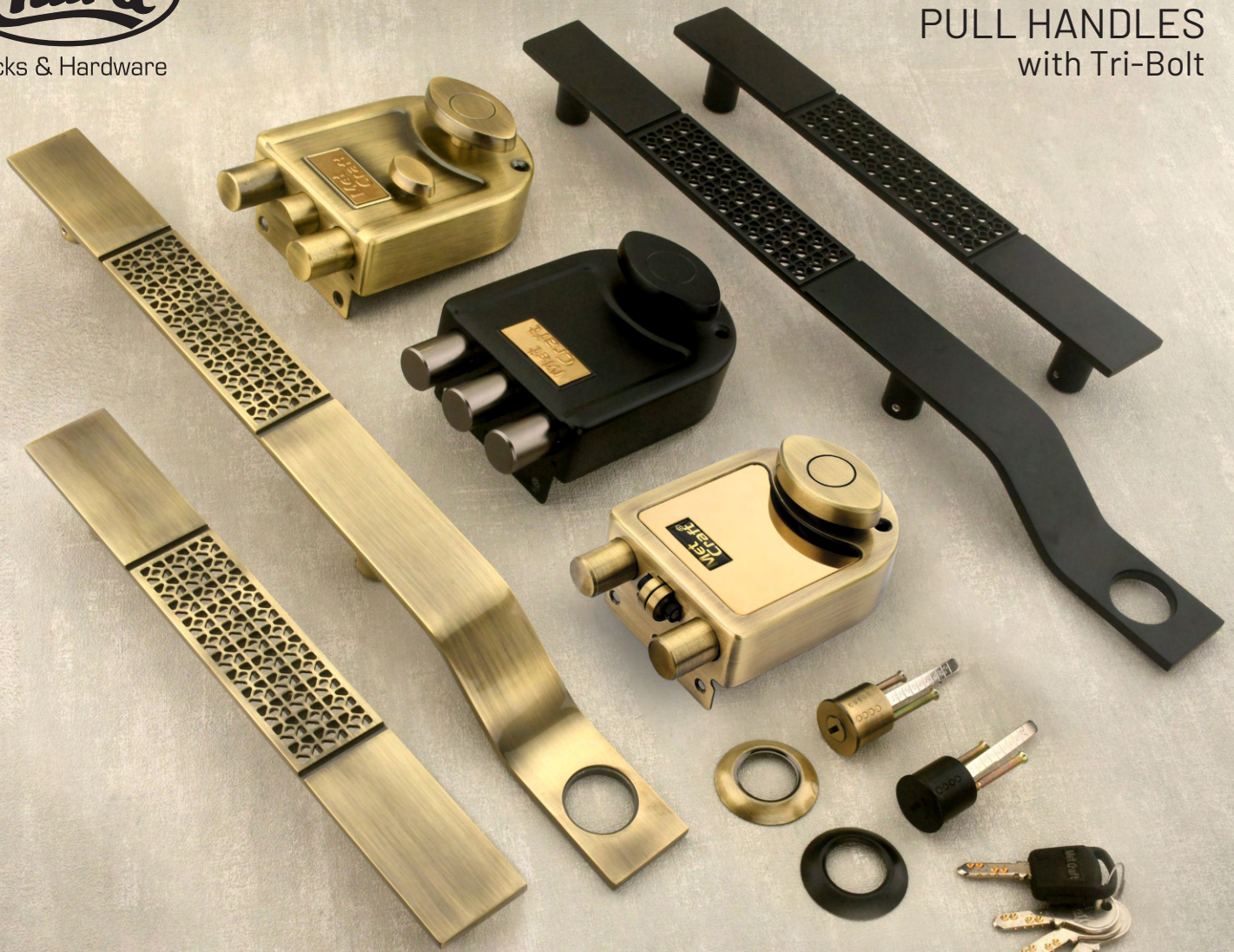

SPHTBL 01 - Phoenix

- Size : 300mm
- Material : Stainless Steel
- Finish : ABM / BM
- Description : Pull Handle with Tribolt use for Wooden Doors

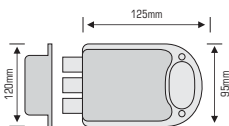

Tribolt

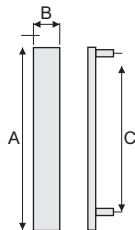

A1

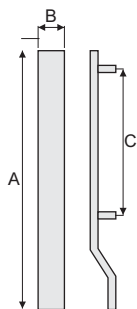

A2



Front

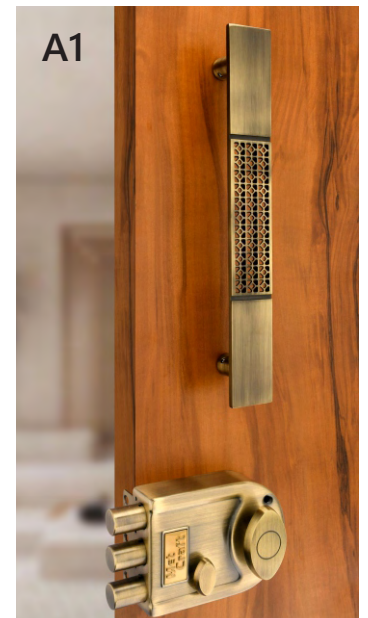

Back

Type	A (mm/Inch)	B (mm)	C (mm)	Packing/Box	TRI BOLT OSK SET	SET TRI BOLT BSK / NIGHT LATCH OSK
A1	300/12	50	250	1 Pc	7670/-	8260/-
A2	450/18	50	250	1 Pc		

Note- Each set Include One Front Handle, One Back Handle & One Tri Bolt





Locks & Hardware

SS 304 PULL HANDLES with Mortice Lock



Anchor

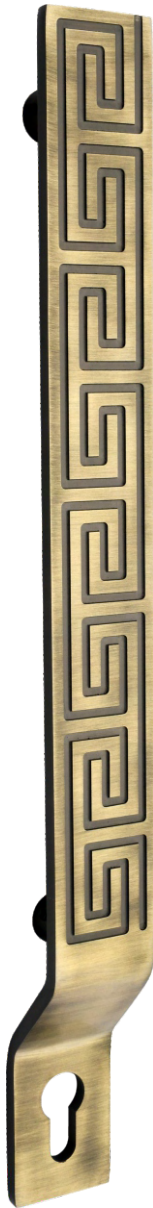

Rozer

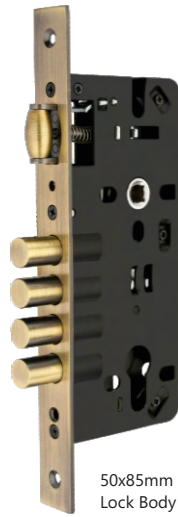

50x85mm
Lock Body



OSK Cylinder
70mm



4 Keys

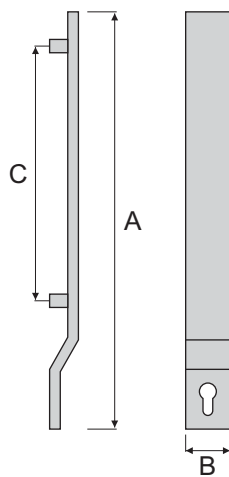

- SHL 01 - Roma
- SHL 02 - Anchor
- SHL 03 - Rozer

Size : 350mm
Material : SS
Finish : ABM

Design	A (mm/Inch)	B (mm)	C (mm)	Packing/Box	MRP/Set
SHL 01	400/16	40	210	1 Set	6490/-
SHL 02	400/16	40	210	1 Set	5840/-
SHL 03	400/16	40	210	1 Set	5840/-



Roma

For Extra :
60mm OSK 83/- (-) Less
60 mm BSK 165/- (-) Less
70 mm BSK 83/- (-) Less





Locks & Hardware



mortise
Handles



Locks & Hardware

ZINC

MORTICE HANDLES

ZMH 50 - Geneva (on Plate)

3670/- Pair

Size : 300mm

Material : Zinc

Finish : ABM

ZMH50-CLB4501-BCU600 (Combo)

5370/- Set

Mortice Handle With CY Lock Body & 60mm Brass Pin Cylinder (3 Brass Comp. Key)

For Extra : 60mm BSK 59/- (-) Less

ZRH 50 (On Rose)

3080/- Pair

Size : Rose

Material : Zinc

Finish : ABM

ZRH50-CLB4501-BCU600 (Combo)

4780/- Set

Rose Handle With CY Lock Body & 60mm Brass Pin Cylinder (3 Brass Comp. Key)

For Extra : 60mm BSK 59/- (-) Less

ZMH 51 - Zurich (On Plate)

3670/- Pair

Size : 300mm

Material : Zinc

Finish : ABM

ZMH51-CLB4501-BCU600 (Combo)

5370/- Set

Mortice Handle With CY Lock Body & 60mm Brass Pin Cylinder (3 Brass Comp. Key)

For Extra : 60mm BSK 59/- (-) Less

ZRH 51 (On Rose)

3080/- Pair

Size : Rose

Material : Zinc

Finish : ABM

ZRH51-CLB4501-BCU600 (Combo)

4780/- Set

Rose Handle With CY Lock Body & 60mm Brass Pin Cylinder (3 Brass Comp. Key)

For Extra : 60mm BSK 59/- (-) Less





Locks & Hardware

ZINC ROSE HANDLES



ZRH 60 (On Rose)

2550/- Pair

Size : Rose
Material : Zinc
Finish : AB / BM

ZRH60-CLB4501-BCU600 (Combo)

4250/- Set

Rose Handle With CY Lock Body & 60mm Brass
Pin Cylinder (3 Brass Comp. Key)

For Extra : 60mm BSK 59/- (-) Less



ZRH 61 (On Rose)

2550/- Pair

Size : Rose
Material : Zinc
Finish : AB / BM

ZRH61-CLB4501-BCU600 (Combo)

4250/- Set

Rose Handle With CY Lock Body & 60mm Brass
Pin Cylinder (3 Brass Comp. Key)

For Extra : 60mm BSK 59/- (-) Less





Locks & Hardware

ZINC ROSE HANDLES



ZRH 62 (On Rose)

2840/- Pair

Size : Rose
Material : Zinc
Finish : AB / BM

ZRH62-CLB4501-BCU600 (Combo)

4540/- Set

Rose Handle With CY Lock Body & 60mm Brass Pin Cylinder (3 Brass Comp. Key)

For Extra : 60mm BSK 59/- (-) Less



ZRH 63 (On Rose)

2730/- Pair

Size : Rose
Material : Zinc
Finish : AB / BM

ZRH63-CLB4501-BCU600 (Combo)

4425/- Set

Rose Handle With CY Lock Body & 60mm Brass Pin Cylinder (3 Brass Comp. Key)

For Extra : 60mm BSK 59/- (-) Less





Locks & Hardware

ZINC MORTICE HANDLES

ZMH 44 (On Plate)

2410/- Pair

Size : 200mm

Material : Zinc

Finish : ABM / NSM

ZMH44-CLB4502-BCU600 (Combo) 200mm

3840/- Set

Mortice Handle With CY Lock Body & 60mm Brass Pin Cylinder (3 Brass Comp. Key)

For Extra : 60mm BSK 59/- (-) Less



ZMH 45 (On Plate)

2410/- Pair

Size : 200mm

Material : Zinc

Finish : ABM / NSM

ZMH45-CLB4502-BCU600 (Combo) 200mm

3840/- Set

Mortice Handle With CY Lock Body & 60mm Brass Pin Cylinder (3 Brass Comp. Key)

For Extra : 60mm BSK 59/- (-) Less





Locks & Hardware

ZINC

MORTICE HANDLES

ZMH 37 Biba (On Plate)

2000/- Pair

Size : 200mm

Material : Zinc

Finish : BSM

ZMH37-CLB4502-BCU600 (Combo)

3430/- Set

Mortice Handle With CY Lock Body & 60mm Brass Pin Cylinder (3 Brass Comp. Key)

For Extra : 60mm BSK 59/- (-) Less

ZRH 37 Biba (On Rose)

2250/- Pair



ZRH37-CLB4501-BCU600 (Combo)

3950/- Set

Rose Handle With CY Lock Body & 60mm Zinc Pin Cylinder (3 Brass Comp. Key)

For Extra : 60mm BSK 59/- (-) Less

ZMH 01 (On Plate)

1470/- Pair

Size : 200mm

Material : Zinc

Finish : ABM

ZMH50-CLB4502-BCU600 (Combo)

2900/- Set

Mortice Handle With CY Lock Body & 60mm Brass Pin Cylinder (3 Brass Comp. Key)

For Extra : 60mm BSK 59/- (-) Less

ZRH 01 (On Rose)

1720/- Pair



ZRH01-CLB4501-BCU600 (Combo)

3420/- Set

Rose Handle With CY Lock Body & 60mm Zinc Pin Cylinder (3 Brass Comp. Key)

For Extra : 60mm BSK 59/- (-) Less





Locks & Hardware

ZINC

MORTICE HANDLES



ZMH 02 (On Plate)

1470/- Pair

Size : 200mm

Material : Zinc

Finish : ABM

ZMH02-CLB4502-BCU600 (Combo)

2900/- Set

Mortice Handle With CY Lock Body & 60mm Brass Pin Cylinder (3 Brass Comp. Key)

For Extra : 60mm BSK 59/- (-) Less

ZRH 02 (On Rose)

1720/- Pair



ZRH02-CLB4501-BCU600 (Combo)

3420/- Set

Rose Handle With CY Lock Body & 60mm Zinc Pin Cylinder (3 Brass Comp. Key)

For Extra : 60mm BSK 59/- (-) Less



ZMH 03 (On Plate)

1580/- Pair

Size : 200mm

Material : Zinc

Finish : ABM

ZMH03-CLB4502-BCU600 (Combo)

3010/- Set

Mortice Handle With CY Lock Body & 60mm Brass Pin Cylinder (3 Brass Comp. Key)

For Extra : 60mm BSK 59/- (-) Less

ZRH 03 (On Rose)

1840/- Pair



ZRH03-CLB4501-BCU600 (Combo)

3540/- Set

Rose Handle With CY Lock Body & 60mm Zinc Pin Cylinder (3 Brass Comp. Key)

For Extra : 60mm BSK 59/- (-) Less





Locks & Hardware

ZINC MORTICE HANDLES

ZMH 05 (On Plate)

1820/- Pair

Size : 200mm

Material : Zinc

Finish : ABM

ZMH05-CLB4502-BCU600 (Combo)

3250/- Set

Mortice Handle With CY Lock Body & 60mm Brass Pin Cylinder (3 Brass Comp. Key)

For Extra : 60mm BSK 59/- (-) Less

ZRH 05 (On Rose)

2130/- Pair

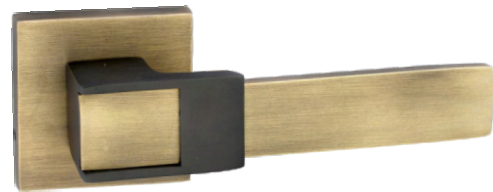

ZRH05-CLB4501-BCU600 (Combo)

3835/- Set

Rose Handle With CY Lock Body & 60mm Zinc Pin Cylinder (3 Brass Comp. Key)

For Extra : 60mm BSK 59/- (-) Less

ZMH 08 (On Plate)

1760/- Pair

Size : 200mm

Material : Zinc

Finish : ABM

ZMH08-CLB4502-BCU600 (Combo)

3190/- Set

Mortice Handle With CY Lock Body & 60mm Brass Pin Cylinder (3 Brass Comp. Key)

For Extra : 60mm BSK 59/- (-) Less

ZRH 08 (On Rose)

2020/- Pair



ZRH08-CLB4501-BCU600 (Combo)

3720/- Set

Rose Handle With CY Lock Body & 60mm Zinc Pin Cylinder (3 Brass Comp. Key)

For Extra : 60mm BSK 59/- (-) Less



ZMH 33 Euro (On Plate)

Size : 200mm **2115/- Pair (AB)**
 Material : Zinc **2290/- Pair (RGB)**
 Finish : AB / RGB

ZMH33-CLB4502-BCU600 (Combo)

3540/- Set (AB) **3720/- Set (RGB)**

Mortice Handle With CY Lock Body & 60mm Brass Pin Cylinder (3 Brass Comp. Key)
 For Extra : 60mm BSK 59/- (-) Less

ZRH 33 Euro (On Rose)

2250/- Pair (AB) **2430/- Pair (RGB)**

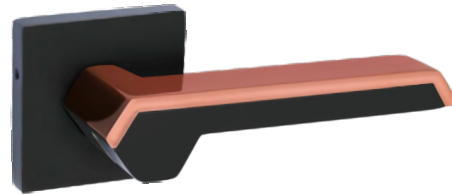

ZRH33-CLB4501-BCU600 (Combo)

3950/- Set (AB) **4130/- Set (RGB)**

Rose Handle With CY Lock Body & 60mm Zinc Pin Cylinder (3 Brass Comp. Key)
 For Extra : 60mm BSK 59/- (-) Less

ZMH 34 Glide (On Plate)

Size : 200mm **2115/- Pair (AB)**
 Material : Zinc **2290/- Pair (RGB)**
 Finish : AB / RGB

ZMH34-CLB4502-BCU600 (Combo)

3540/- Set (AB) **3720/- Set (RGB)**

Mortice Handle With CY Lock Body & 60mm Brass Pin Cylinder (3 Brass Comp. Key)
 For Extra : 60mm BSK 59/- (-) Less

ZRH 34 Glide (On Rose)

2250/- Pair (AB) **2430/- Pair (RGB)**

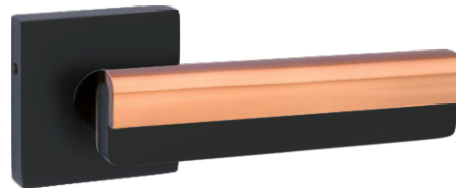

ZRH34-CLB4501-BCU600 (Combo)

3950/- Set (AB) **4130/- Set (RGB)**

Rose Handle With CY Lock Body & 60mm Zinc Pin Cylinder (3 Brass Comp. Key)
 For Extra : 60mm BSK 59/- (-) Less





ALRH 02 LIVO (On Rose) (ABM)

1370/- Pair

ALRH01-CLB4501-BCU600 (Combo)

3070/- Set

Mortice Handle With CY Lock Body & 60mm Brass Pin Cylinder (3 Brass Comp. Key)
For Extra : 60mm BSK 59/- (-) Less

ALRH01-BLL01(Combo)

1416/- Set

(On Rose Handle With Baby Latch)



ALRH 02 FORTUNE (On Rose)(ABM)

1370/- Pair

ALRH02-CLB4501-BCU600 (Combo)

3070/- Set

Mortice Handle With CY Lock Body & 60mm Brass Pin Cylinder (3 Brass Comp. Key)
For Extra : 60mm BSK 59/- (-) Less

ALRH02-BLL01(Combo)

1416/- Set

(On Rose Handle With Baby Latch)



ALRH 03 QUBO (On Rose)(ABM)

1370/- Pair

ALRH03-CLB4501-BCU600 (Combo)

3070/- Set

Mortice Handle With CY Lock Body & 60mm Brass Pin Cylinder (3 Brass Comp. Key)
For Extra : 60mm BSK 59/- (-) Less

ALRH03-BLL01(Combo)

1416/- Set

(On Rose Handle With Baby Latch)



ALRH 04 GUSTO (On Rose)(ABM)

1370/- Pair

ALRH04-CLB4501-BCU600 (Combo)

3070/- Set

Mortice Handle With CY Lock Body & 60mm Brass Pin Cylinder (3 Brass Comp. Key)
For Extra : 60mm BSK 59/- (-) Less

ALRH04-BLL01(Combo)

1416/- Set

(On Rose Handle With Baby Latch)





Locks & Hardware

Stainless Steelmortise Handles



SMH 1043

Finish: NSM/ABM/BM

Code	Size	Packing Box	MRP	
			NSM	ABM/BM
SMH1043Pair)	200mm	1 Pair	1280/-	1430/-
SMH1043-KLB70S(KY Combo)	200mm	1 Set.	1770/-	1920/-
SMH1043-CLB4502-BCU600(CY Combo-Plate)	200mm	1 Set.	2714/-	2860/-
SRH1043-CLB4501-BCU600(CY Combo-Rose)	On Rose	1 Set.	3320/-	3470/-
SBL1043-BLL01 (Bathroom latch Combo Plate)	115mm	1 Set.	1490/-	1640/-
SRH1043-BLL01 (Bathroom latch Combo Rose)	On Rose	1 Set.	1920/-	2070/-

For Extra : 60mm BSK 59/- (-) Less



Locks & Hardware

STAINLESS STEEL MORTICE HANDLES



SMH 1044
Finish: ABM/BSM

Code	Size	Packing Box	MRP ABM/BSM
SMH1044(Pair)	200mm	1 Pair	1440/-
SMH1044-KLB70S(KY Combo)	200mm	1 Set.	1950/-
SMH1044-CLB4502-BCU600(CY Combo-Plate)	200mm	1 Set.	2880/-
SRH1044-CLB4501-BCU600(CY Combo-Rose)	On Rose	1 Set.	3625/-
SBL1044-BLL01 (Bathroom latch Combo Plate)	115mm	1 Set.	1675/-
SRH1044-BLL01 (Bathroom latch Combo Rose)	On Rose	1 Set.	2225/-

For Extra : 60mm BSK 59/- (-) Less



SMH 1045
Finish: ABM/BSM

Code	Size	Packing Box	MRP ABM/BSM
SMH1045(Pair)	200mm	1 Pair	1440/-
SMH1045-KLB70S(KY Combo)	200mm	1 Set.	1950/-
SMH1045-CLB4502-BCU600(CY Combo-Plate)	200mm	1 Set.	2880/-
SRH1045-CLB4501-BCU600(CY Combo-Rose)	On Rose	1 Set.	3625/-
SBL1045-BLL01 (Bathroom latch Combo Plate)	115mm	1 Set.	1675/-
SRH1045-BLL01 (Bathroom latch Combo Rose)	On Rose	1 Set.	2225/-

For Extra : 60mm BSK 59/- (-) Less





Locks & Hardware

STAINLESS STEEL MORTICE HANDLES



SMH 1013

Size : 190mm
Material : Stainless Steel
Finish : AB / SS

SMH1013-KLB70S (Combo)

1475/- Set (SS)
1620/- Set (AB)

Mortice Handle With KY Lock Body (3 Regular Key)



SMH 1014

Size : 190mm
Material : Stainless Steel
Finish : AB / SS

SMH1014-KLB70S (Combo)

1475/- Set (SS)
1620/- Set (AB)

Mortice Handle With KY Lock Body (3 Regular Key)



SMH 1015

Size : 200mm
Material : Stainless Steel
Finish : AB / SS

SMH1015-KLB70S (Combo)

1475/- Set (SS) **1620/- Set (AB)**

Mortice Handle With KY Lock Body (3 Regular Key)

SMH1015-CLB4502-BCU600 (Combo)

2537/- Set (SS) **2680/- Set (AB)**

Mortice Handle With CY Lock Body & 60mm Zinc Pin Cylinder (3 Brass Comp. Keys)

For Extra : 60mm BSK 59/- (-) Less





Locks & Hardware

STAINLESS STEEL MORTICE HANDLES



SMH 1005

Size : 200mm
Material : Stainless Steel
Finish : AB / SS

SMH1005-KLB70S (Combo)

1652/- Set (SS) 1770/- Set (AB)

Mortice Handle With KY Lock Body (3 Regular Key)

SMH1005-CLB4502-BCU600 (Combo)

2478/- Set (SS) 2620/- Set (AB)

Mortice Handle With CY Lock Body & 60mm Zinc Pin Cylinder (3 Brass Comp. Keys)

For Extra : 60mm BSK 59/- (-) Less



SMH 1040

Size : 200mm
Material : Stainless Steel
Finish : AB / SS

SMH1040-KLB70S (Combo)

1947/- Set (AB/SS)

Mortice Handle With KY Lock Body (3 Regular Key)

SMH1040-CLB4502-BCU600 (Combo)

2832/- Set (AB/SS)

Mortice Handle With CY Lock Body & 60mm Zinc Pin Cylinder (3 Brass Comp. Keys)

For Extra : 60mm BSK 59/- (-) Less



SMH 1016

Size : 200mm
Material : Stainless Steel
Finish : ABM / BM

SMH1016-KLB70S (Combo)

1947/- Set (ABM/BM)

Mortice Handle With KY Lock Body (3 Regular Key)

SMH1016-CLB4502-BCU600 (Combo)

2860/- Set (ABM/BM)

Mortice Handle With CY Lock Body & 60mm Zinc Pin Cylinder (3 Brass Comp. Keys)

For Extra : 60mm BSK 59/- (-) Less



STAINLESS STEEL MORTICE HANDLES



SMH 1041

Size : 200mm
Material : Stainless Steel
Finish : AB / SS

SMH1041-KLB70S (Combo)

1725/- Set (SS/AB)

Mortice Handle With KY Lock Body (3 Regular Key)

SMH1041-CLB4502-BCU600 (Combo)

2420/- Set (SS/AB)

Mortice Handle With CY Lock Body & 60mm Zinc Pin Cylinder (3 Brass Comp. Keys)

For Extra : 60mm BSK 59/- (-) Less

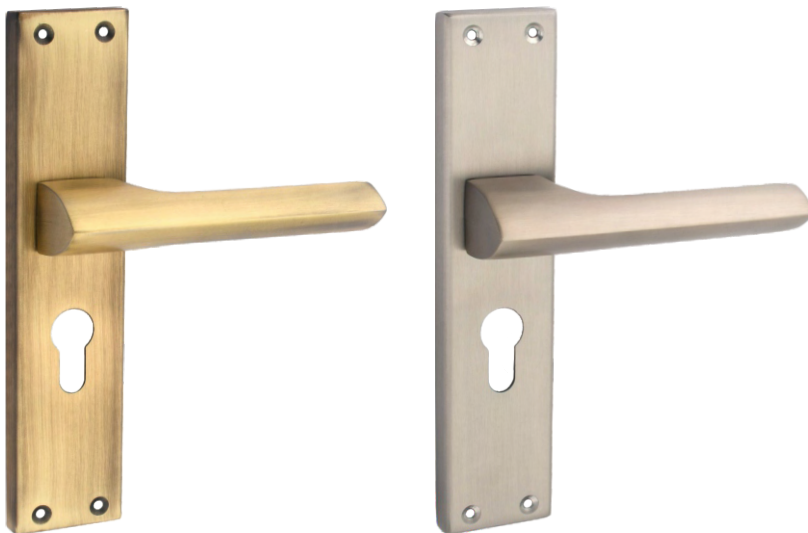

SMH 1042

Size : 200mm
Material : Stainless Steel
Finish : SS/AB

SMH1042-KLB70S (Combo)

1550/- Set (SS/AB)

Mortice Handle With KY Lock Body (3 Regular Key)

SMH1042-CLB4502-BCU600 (Combo)

2420/- Set (SS/AB)

Mortice Handle With CY Lock Body & 60mm Zinc Pin Cylinder (3 Brass Comp. Keys)

For Extra : 60mm BSK 59/- (-) Less

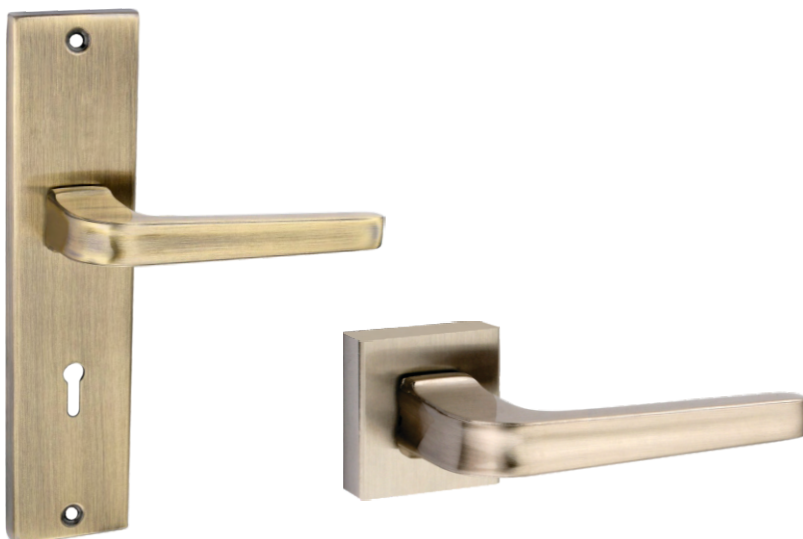

SMH 1039

Size : 200mm
Material : Stainless Steel
Finish : SS/AB

SMH1039-KLB70S (Combo)

2080/- Set (AB/SS)

Mortice Handle With KY Lock Body (3 Regular Key)

SMH1039-CLB4502-BCU600 (Combo)

3260/- Set (AB/SS) 3350/- Set (RG/BM)

SRH1039-CLB4501-BCU600 (On Rose Combo)

3870/- Set (AB/SS) 3920/- Set (RG/BM)

Mortice Handle With CY Lock Body & 60mm Brass Pin Cylinder (3 Brass Comp. Keys)

For Extra : 60mm BSK 59/- (-) Less





Locks & Hardware

STAINLESS STEEL MORTICE HANDLES



SMH 1037

Size : 200mm
Material : Stainless Steel
Finish : AB

SMH1037-KLB70S (Combo)

1510/- Set (AB)

Mortice Handle With KY Lock Body (3 Regular Key)



SMH 1038

Size : 200mm
Material : Stainless Steel
Finish : AB

SMH1038-KLB70S (Combo)

1510/- Set (AB)

Mortice Handle With KY Lock Body (3 Regular Key)

IMH 1013

Size : 200mm
Material : Iron
Finish : ABM/BSM

IMH 1013-KLB70S (Combo)

1416/- Set (ABM/BSM)

Mortice Handle With KY Lock Body (3 Regular Key)

IRON MORTICE HANDLES





Locks & Hardware

IRON MORTICE HANDLES



IMH 1011

Size : 200mm
Material : Iron
Finish : MAB / BSM

IMH1011-KLB70S (Combo)

1465/- Set (MAB/BSM)

Mortice Handle With KY Lock Body (3 Regular Key)



IMH 1012

Size : 200mm
Material : Iron
Finish : MAB / BSM

IMH1012-KLB70S (Combo)

1465/- Set (MAB/BSM)

Mortice Handle With KY Lock Body (3 Regular Key)

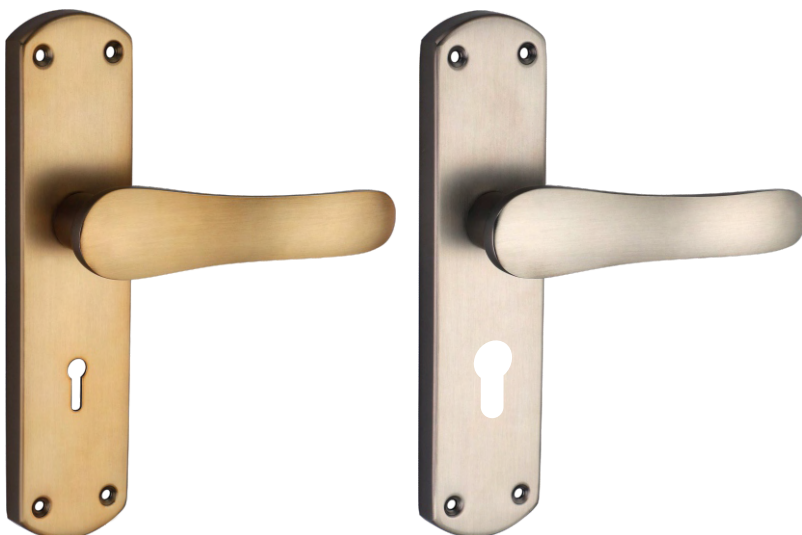

IMH 1006

Size : 200mm
Material : Iron
Finish : MAB / BSM

IMH1006-KLB70S (Combo)

1298/- Set (MAB/BSM)

Mortice Handle With KY Lock Body (3 Regular Key)

IMH1006-CLB4502-ZCU60O (Combo)

2210/- Set (MAB/BSM)

Mortice Handle With CY Lock Body & 60mm Zinc Pin Cylinder (3 Brass Comp. Keys)

For Extra : 60 mm BSK 59/- (-) Less





Locks & Hardware

IRON MORTICE HANDLES



IMH 1007

Size : 200mm
Material : Iron
Finish : ABM / BSM

IMH1007-KLB70S (Combo)

1298/- Set (ABM/BSM)

Mortice Handle With KY Lock Body (3 Regular Key)



IMH 1014

Size : 175mm
Material : Iron
Finish : ABM / RGB

IMH1014-KLB65S (Combo)

1180/- Set (ABM/RGB)

Mortice Handle With KY Lock Body (3 Regular Key)



IMH 302

Size : 175mm
Material : Iron
Finish : ABM / BSM

IMH302-KLB65S (Combo)

920/- Set (ABM/BSM)

Mortice Handle With KY Lock Body (3 Regular Key)





Locks & Hardware

IRON MORTICE HANDLES



IMH 303

Size : 175mm
Material : Iron
Finish : ABM / BSM

IMH303-KLB65S (Combo)

920/- Set (ABM/BSM)

Mortice Handle With KY Lock Body (3 Regular Key)



IMH 304

Size : 175mm
Material : Iron
Finish : ABM / BSM

IMH304-KLB65S (Combo)

920/- Set (ABM/BSM)

Mortice Handle With KY Lock Body (3 Regular Key)



IMH 305

Size : 175mm
Material : Iron
Finish : ABM / BSM

IMH305-KLB65S (Combo)

920/- Set (ABM/BSM)

Mortice Handle With KY Lock Body (3 Regular Key)



IMH 307

Size : 175mm
Material : Iron
Finish : ABM / BSM

IMH307-KLB65S (Combo)

920/- Set (ABM/BSM)

Mortice Handle With KY Lock Body (3 Regular Key)





Locks & Hardware

ZINC BABY LATCHES



ZBL 01

Size : 115mm
Material : Zinc
Finish : AB / BS

ZBL01-BLL01 (Combo)
1416/- Set
Mortice Latch With Latch Body



ZBL 03

Size : 115mm
Material : Zinc
Finish : AB / BS

ZBL03-BLL01 (Combo)
1535/- Set
Mortice Latch With Latch Body

STAINLESS STEEL BABY MORTICE LATCHES



SBL 1014

Size : 115mm
Material : Stainless Steel
Finish : SS / AB

SBL1014-BLL01 (Combo)
1145/- Set (SS)
1239/- Set (AB)
Mortice Latch With Latch Body

IRON BABY MORTICE LATCHES



IBL 001

Size : 115mm
Material : Iron
Finish : ABM / BSM

IBL301-BLL01 (Combo)
732/- Set
Mortice Latch With Latch Body





CLB4501B

Material: Brass
Finish: SS / AB / BL
Description: CY Large Mortice Lock Body With Brass Latch & Bolt (Without Cylinder)

Size (in mm)	Packing Box	SS	AB	BL
45x85	1 Pc.		840/-	



CLB4502B

Material: Brass
Finish: SS / AB / BL
Description: CY Small Mortice Lock Body With Brass Latch & Bolt (Without Cylinder)

Size (in mm)	Packing Box	SS	AB	BL
45x45	1 Pc.		570/-	



KLB70S

Material: Brass
Finish: SS / AB
Description: KY Small Mortice Lock Body With Brass Latch & Bolt 6 Lvr., D/A, 3 Cp Keys

Size (in mm)	Packing/Box	SS	AB
70	1 Pc.	472/-	510/-



KLB65S

Finish: SS
Description: KY Small Mortice Lock Body With Brass Latch & Bolt 6 Lvr., D/A, 3 Cp Keys

Size (in mm)	Packing/Box	SS
65	1 Pc.	390/-



BLL01

Finish: SS / AB
Description: Alu. Latch & Alu. Spindle

Size (in mm)	Packing/Box	SS/AB
65	1 Pc.	300/-





Locks & Hardware

BRASS CYLINDERS



BSK

Finish: AB / SS / BM

Description: Pin Cylinder Both Side Key
(3 Brass Ultra Keys)

Code	Size	Packing Box	MRP
BCU60B	60mm	1 Pc.	805/-

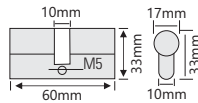

OSK

Finish: AB / SS / BM

Description: Pin Cylinder Both Side Key
(3 Brass Ultra Keys)

Code	Size	Packing Box	MRP
BCU600	60mm	1 Pc.	860/-

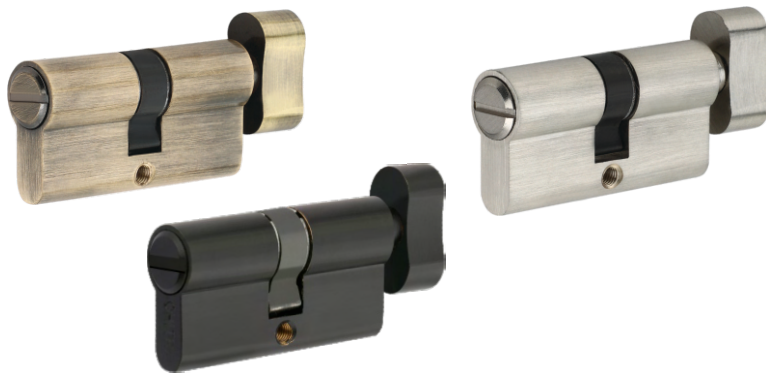
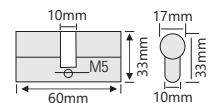

OSK Coin (Bathroom)

Finish: AB / SS / BM

Description: Bathroom Pin Cylinder

Code	Size	Packing Box	MRP
BCU60C	60mm	1 Pc.	860/-

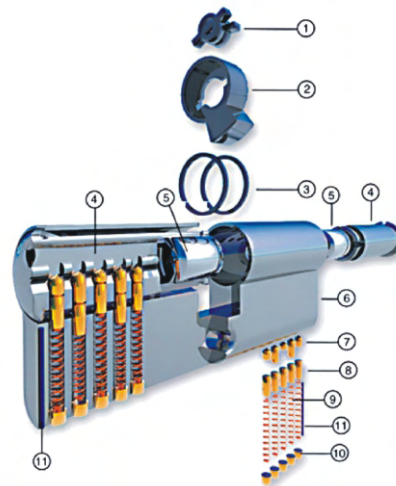
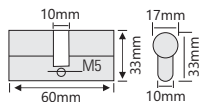

1. Clutch
2. Cam
3. Clip Rings
4. Barrel
5. Spacer
Long Cylinder Only
6. Housing
7. Key Pins
8. Middle Pins
9. Springs
10. Closing Pins
11. Anti-drill Pin





Locks & Hardware



brass
door kits



LEGEND Series

Material: Brass

Size: 16mm/10"/12"/14"/16"
12mm/8"/10"/12"

Finish: Coffee Red

Brass Aldrop 16mm		
Size	Packing / Box	MRP/Pc
16mm 10" (2+1)	1 Pc.	1752/-
16mm 10" (3+1)	1 Pc.	2010/-
16mm 12" (3+1)	1 Pc.	2085/-
16mm 14" (3+1)	1 Pc.	2160/-

Extra Cram			Extra Locking Kunda		
Size	Packing / Box	MRP/Pc	Size	Packing / Box	MRP/Pc
16mm	10 Pc.	260/-	16mm	10 Pc.	260/-

Brass Pull Handle on Rose		
Size	Packing / Box	MRP/Pc
200mm	2 Pc.	1145/-
250mm	2 Pc.	1560/-

Main Door Kit		
Size	Packing / Box	MRP/Set
16mm Single	1 Set	6135/-
16mm Double	1 Set	9440/-

Brass Aldrop 12mm		
Size	Packing / Box	MRP/Pc
12mm 8" (3+1)	2 Pc.	1170/-
12mm 10" (3+1)	2 Pc.	1205/-
12mm 12" (3+1)	2 Pc.	1240/-

Brass Latch 12mm		
Size	Packing / Box	MRP/Pc
12mm 8" (3)	2 Pc.	1015/-
12mm 10" (3)	2 Pc.	1050/-
12mm 12" (3)	2 Pc.	1085/-

Extra Cram			Extra Locking Kunda		
Size	Packing / Box	MRP/Pc	Size	Packing / Box	MRP/Pc
12mm	10 Pc.	185/-	12mm	10 Pc.	185/-

Brass Cabinet Handle (F/S)			Brass Stopper		
Size	Packing / Box	MRP/Pc	Size	Packing / Box	MRP/Pc
165mm	10 Pc.	390/-	125mm	10 Pc.	530
200mm	10 Pc.	495/-			





VIEANA Series

Material: Brass
Size: 16mm/10"/12"/14"/16"
Finish: ABM

Brass Aldrop 16mm		
Size	Packing / Box	MRP/Pc
16mm 10" (2+1)	1 Pc.	1780/-
16mm 10" (3+1)	1 Pc.	2035/-
16mm 12" (3+1)	1 Pc.	2105/-
16mm 14" (3+1)	1 Pc.	2185/-

Extra Cram			Extra Locking Kunda		
Size	Packing / Box	MRP/Pc	Size	Packing / Box	MRP/Pc
16mm	10 Pc.	255/-	16mm	10 Pc.	235/-

Brass Pull Handle on Rose		
Size	Packing / Box	MRP/Pc
200mm	2 Pc.	1320/-
250mm	2 Pc.	1610/-

Main Door Kit		
Size	Packing / Box	MRP/Set
16mm Single	1 Set	6372/-
16mm Double	1 Set	10030/-

Brass Aldrop 12mm		
Size	Packing / Box	MRP/Pc
12mm 8" (3+1)	2 Pc.	1250/-
12mm 10" (3+1)	2 Pc.	1285/-
12mm 12" (3+1)	2 Pc.	1320/-

Brass Latch 12mm		
Size	Packing / Box	MRP/Pc
12mm 8" (3)	2 Pc.	1040/-
12mm 10" (3)	2 Pc.	1075/-
12mm 12" (3)	2 Pc.	1110/-

Extra Cram			Extra Locking Kunda		
Size	Packing / Box	MRP/Pc	Size	Packing / Box	MRP/Pc
12mm	10 Pc.	185/-	12mm	10 Pc.	185/-

Brass Cabinet Handle (F/S)			Brass Stopper		
Size	Packing / Box	MRP/Pc	Size	Packing / Box	MRP/Pc
150mm	10 Pc.	400/-	125mm	10 Pc.	590/-





VINAYAK Series

Material: Brass

Size: 16mm/10"/12"/14"/16"
12mm/8"/10"/12"

Finish: ABM

Brass Aldrop 16mm		
Size	Packing / Box	MRP/Pc
16mm 10" (2+1)	1 Pc.	1805/-
16mm 10" (3+1)	1 Pc.	2065/-
16mm 12" (3+1)	1 Pc.	2135/-
16mm 14" (3+1)	1 Pc.	2215/-

Extra Cram			Extra Locking Kunda		
Size	Packing / Box	MRP/Pc	Size	Packing / Box	MRP/Pc
16mm	10 Pc.	260/-	16mm	10 Pc.	260/-

Brass Pull Handle on Rose		
Size	Packing / Box	MRP/Pc
200mm	2 Pc.	1075/-
250mm	2 Pc.	1475/-

Main Door Kit		
Size	Packing / Box	MRP/Set
16mm Single	1 Set	6135
16mm Double	1 Set	9560

Brass Aldrop 12mm		
Size	Packing / Box	MRP/Pc
12mm 8" (3+1)	2 Pc.	1240/-
12mm 10" (3+1)	2 Pc.	1275/-
12mm 12" (3+1)	2 Pc.	1310/-

Brass Latch 12mm		
Size	Packing / Box	MRP/Pc
12mm 8" (3)	2 Pc.	1040/-
12mm 10" (3)	2 Pc.	1075/-
12mm 12" (3)	2 Pc.	1110/-

Extra Cram			Extra Locking Kunda		
Size	Packing / Box	MRP/Pc	Size	Packing / Box	MRP/Pc
12mm	10 Pc.	185/-	12mm	10 Pc.	185/-

Brass Cabinet Handle (F/S)			Brass Stopper		
Size	Packing / Box	MRP/Pc	Size	Packing / Box	MRP/Pc
150mm	10 Pc.	380/-	125mm	10 Pc.	530
175mm	10 Pc.	435/-			



*Forged
Brass*



GANESH JI Series

Material: Brass

Size: 16mm/10"/12"/14"/16"
12mm/8"/10"/12"

Finish: ABM

Brass Aldrop 16mm		
Size	Packing / Box	MRP/Pc
16mm 10" (2+1)	1 Pc.	1780/-
16mm 10" (3+1)	1 Pc.	2035/-
16mm 12" (3+1)	1 Pc.	2105/-
16mm 14" (3+1)	1 Pc.	2185/-

Extra Cram			Extra Locking Kunda		
Size	Packing / Box	MRP/Pc	Size	Packing / Box	MRP/Pc
16mm	10 Pc.	255/-	16mm	10 Pc.	235/-

Brass Pull Handle on Rose		
Size	Packing / Box	MRP/Pc
200mm	2 Pc.	1155/-
250mm	2 Pc.	1440/-

Main Door Kit		
Size	Packing / Box	MRP/Set
16mm Single	1 Set	6100/-
16mm Double	1 Set	9440/-

Brass Aldrop 12mm		
Size	Packing / Box	MRP/Pc
12mm 8" (3+1)	2 Pc.	1250/-
12mm 10" (3+1)	2 Pc.	1285/-
12mm 12" (3+1)	2 Pc.	1320/-

Brass Latch 12mm		
Size	Packing / Box	MRP/Pc
12mm 8" (3)	2 Pc.	1040/-
12mm 10" (3)	2 Pc.	1075/-
12mm 12" (3)	2 Pc.	1110/-

Extra Cram			Extra Locking Kunda		
Size	Packing / Box	MRP/Pc	Size	Packing / Box	MRP/Pc
12mm	10 Pc.	185/-	12mm	10 Pc.	185/-

Brass Cabinet Handle (F/S)			Brass Stopper		
Size	Packing / Box	MRP/Pc	Size	Packing / Box	MRP/Pc
150mm	10 Pc.	355/-	125mm	10 Pc.	530/-





GANESH JI Series

Material: Brass

Size: 16mm/10"/12"/14"/16"
12mm/8"/10"/12"

Finish: BGC

Brass Aldrop 16mm		
Size	Packing / Box	MRP/Pc
16mm 10" (2+1)	1 Pc.	1770/-
16mm 10" (3+1)	1 Pc.	2095/-
16mm 12" (3+1)	1 Pc.	2165/-
16mm 14" (3+1)	1 Pc.	2240/-

Extra Cram			Extra Locking Kunda		
Size	Packing / Box	MRP/Pc	Size	Packing / Box	MRP/Pc
16mm	10 Pc.	270/-	16mm	10 Pc.	250/-

Brass Pull Handle on Rose		
Size	Packing / Box	MRP/Pc
200mm	2 Pc.	1220/-
250mm	2 Pc.	2560/-

Main Door Kit		
Size	Packing / Box	MRP/Set
16mm Single	1 Set	6300/-
16mm Double	1 Set	9770/-

Brass Aldrop 12mm		
Size	Packing / Box	MRP/Pc
12mm 8" (3+1)	2 Pc.	1285/-
12mm 10" (3+1)	2 Pc.	1320/-
12mm 12" (3+1)	2 Pc.	1355/-

Brass Latch 12mm		
Size	Packing / Box	MRP/Pc
12mm 8" (3)	2 Pc.	1075/-
12mm 10" (3)	2 Pc.	1110/-
12mm 12" (3)	2 Pc.	1145/-

Extra Cram			Extra Locking Kunda		
Size	Packing / Box	MRP/Pc	Size	Packing / Box	MRP/Pc
12mm	10 Pc.	190/-	12mm	10 Pc.	190/-

Brass Cabinet Handle (F/S)			Brass Stopper		
Size	Packing / Box	MRP/Pc	Size	Packing / Box	MRP/Pc
150mm	10 Pc.	365/-	125mm	10 Pc.	550/-





CARVING Series

Material: Brass

Size: 16mm/10"/12"/14"/16"
12mm/8"/10"/12"

Finish: ABM

Brass Aldrop 16mm		
Size	Packing / Box	MRP/Pc
16mm 10" (2+1)	1 Pc.	1750/-
16mm 10" (3+1)	1 Pc.	1980/-
16mm 12" (3+1)	1 Pc.	2055/-
16mm 14" (3+1)	1 Pc.	2130/-

Extra Cram			Extra Locking Kunda		
Size	Packing / Box	MRP/Pc	Size	Packing / Box	MRP/Pc
16mm	10 Pc.	230/-	16mm	10 Pc.	230/-

Brass Pull Handle on Rose		
Size	Packing / Box	MRP/Pc
200mm	2 Pc.	1290/-
250mm	2 Pc.	1570/-

Main Door Kit		
Size	Packing / Box	MRP/Set
16mm Single	1 Set	6140/-
16mm Double	1 Set	9620/-

Brass Aldrop 12mm		
Size	Packing / Box	MRP/Pc
12mm 8" (3+1)	2 Pc.	1075/-
12mm 10" (3+1)	2 Pc.	1110/-
12mm 12" (3+1)	2 Pc.	1145/-

Brass Latch 12mm		
Size	Packing / Box	MRP/Pc
12mm 8" (3)	2 Pc.	980/-
12mm 10" (3)	2 Pc.	1015/-
12mm 12" (3)	2 Pc.	1050/-

Extra Cram			Extra Locking Kunda		
Size	Packing / Box	MRP/Pc	Size	Packing / Box	MRP/Pc
12mm	10 Pc.	185/-	12mm	10 Pc.	185/-

Brass Cabinet Handle (F/S)			Brass Stopper		
Size	Packing / Box	MRP/Pc	Size	Packing / Box	MRP/Pc
150mm	10 Pc.	355/-	125mm	10 Pc.	530/-





CARVING Series

Material: Brass
Size: 16mm/10"/12"/14"/16"
Finish: BGC

Brass Aldrop 16mm		
Size	Packing / Box	MRP/Pc
16mm 10" (2+1)	1 Pc.	1810/-
16mm 10" (3+1)	1 Pc.	2040/-
16mm 12" (3+1)	1 Pc.	2110/-
16mm 14" (3+1)	1 Pc.	2190/-

Extra Cram			Extra Locking Kunda		
Size	Packing / Box	MRP/Pc	Size	Packing / Box	MRP/Pc
16mm	10 Pc.	240/-	16mm	10 Pc.	240/-

Brass Pull Handle on Rose		
Size	Packing / Box	MRP/Pc
200mm	2 Pc.	1345/-
250mm	2 Pc.	1630/-

Main Door Kit		
Size	Packing / Box	MRP/Set
16mm Single	1 Set	6315/-
16mm Double	1 Set	9910/-

Brass Aldrop 12mm		
Size	Packing / Box	MRP/Pc
12mm 8" (3+1)	2 Pc.	1110/-
12mm 10" (3+1)	2 Pc.	1145/-
12mm 12" (3+1)	2 Pc.	1180/-

Brass Latch 12mm		
Size	Packing / Box	MRP/Pc
12mm 8" (3)	2 Pc.	1015/-
12mm 10" (3)	2 Pc.	1050/-
12mm 12" (3)	2 Pc.	1085/-

Extra Cram			Extra Locking Kunda		
Size	Packing / Box	MRP/Pc	Size	Packing / Box	MRP/Pc
12mm	10 Pc.	190/-	12mm	10 Pc.	190/-

Brass Cabinet Handle (F/S)			Brass Stopper		
Size	Packing / Box	MRP/Pc	Size	Packing / Box	MRP/Pc
150mm	10 Pc.	365/-	125mm	10 Pc.	550/-





TULIP Series

Material: Brass

Size: 16mm/10"/12"/14"/16"

Finish: Coffee Red

Brass Aldrop 16mm		
Size	Packing / Box	MRP/Pc
16mm 10" (2+1)	1 Pc.	1605/-
16mm 10" (3+1)	1 Pc.	1840/-
16mm 12" (3+1)	1 Pc.	1910/-
16mm 14" (3+1)	1 Pc.	1990/-

Extra Cram			Extra Locking Kunda		
Size	Packing / Box	MRP/Pc	Size	Packing / Box	MRP/Pc
16mm	10 Pc.	235/-	16mm	10 Pc.	235/-

Brass Pull Handle on Rose		
Size	Packing / Box	MRP/Pc
200mm	2 Pc.	1060/-
250mm	2 Pc.	1560/-

Main Door Kit		
Size	Packing / Box	MRP/Set
16mm Single	1 Set	5780/-
16mm Double	1 Set	9145/-

Brass Aldrop 12mm		
Size	Packing / Box	MRP/Pc
12mm 8" (3+1)	2 Pc.	1170/-
12mm 10" (3+1)	2 Pc.	1205/-
12mm 12" (3+1)	2 Pc.	1240/-

Brass Latch 12mm		
Size	Packing / Box	MRP/Pc
12mm 8" (3)	2 Pc.	910/-
12mm 10" (3)	2 Pc.	945/-
12mm 12" (3)	2 Pc.	980/-

Extra Cram			Extra Locking Kunda		
Size	Packing / Box	MRP/Pc	Size	Packing / Box	MRP/Pc
12mm	10 Pc.	185/-	12mm	10 Pc.	185/-

Brass Cabinet Handle (F/S)			Brass Stopper		
Size	Packing / Box	MRP/Pc	Size	Packing / Box	MRP/Pc
150mm	10 Pc.	355/-	125mm	10 Pc.	530/-



*Forged
Brass*



BLOSSOM Series

Material: Brass

Size: 16mm/10"/12"/14"/16"

Finish: Coffee Red

Brass Aldrop 16mm

Size	Packing / Box	MRP/Pc
16mm 10" (2+1)	1 Pc.	1605/-
16mm 10" (3+1)	1 Pc.	1840/-
16mm 12" (3+1)	1 Pc.	1910/-
16mm 14" (3+1)	1 Pc.	1990/-

Brass Aldrop 12mm

Size	Packing / Box	MRP/Pc
12mm 8" (3+1)	2 Pc.	1170/-
12mm 10" (3+1)	2 Pc.	1205/-
12mm 12" (3+1)	2 Pc.	1240/-

Extra Cram

Size	Packing / Box	MRP/Pc
16mm	10 Pc.	235/-

Extra Locking Kunda

Size	Packing / Box	MRP/Pc
16mm	10 Pc.	235/-

Brass Latch 12mm

Size	Packing / Box	MRP/Pc
12mm 8" (3)	2 Pc.	910/-
12mm 10" (3)	2 Pc.	945/-
12mm 12" (3)	2 Pc.	980/-

Brass Pull Handle on Rose

Size	Packing / Box	MRP/Pc
200mm	2 Pc.	1060/-
250mm	2 Pc.	1560/-

Extra Cram

Size	Packing / Box	MRP/Pc
12mm	10 Pc.	185/-

Extra Locking Kunda

Size	Packing / Box	MRP/Pc
12mm	10 Pc.	185/-

Main Door Kit

Size	Packing / Box	MRP/Set
16mm Single	1 Set	5780/-
16mm Double	1 Set	9145/-

Brass Cabinet Handle (F/S)

Size	Packing / Box	MRP/Pc
150mm	10 Pc.	355/-

Brass Stopper

Size	Packing / Box	MRP/Pc
125mm	10 Pc.	530/-





Locks & Hardware

BRASS DOOR KITS

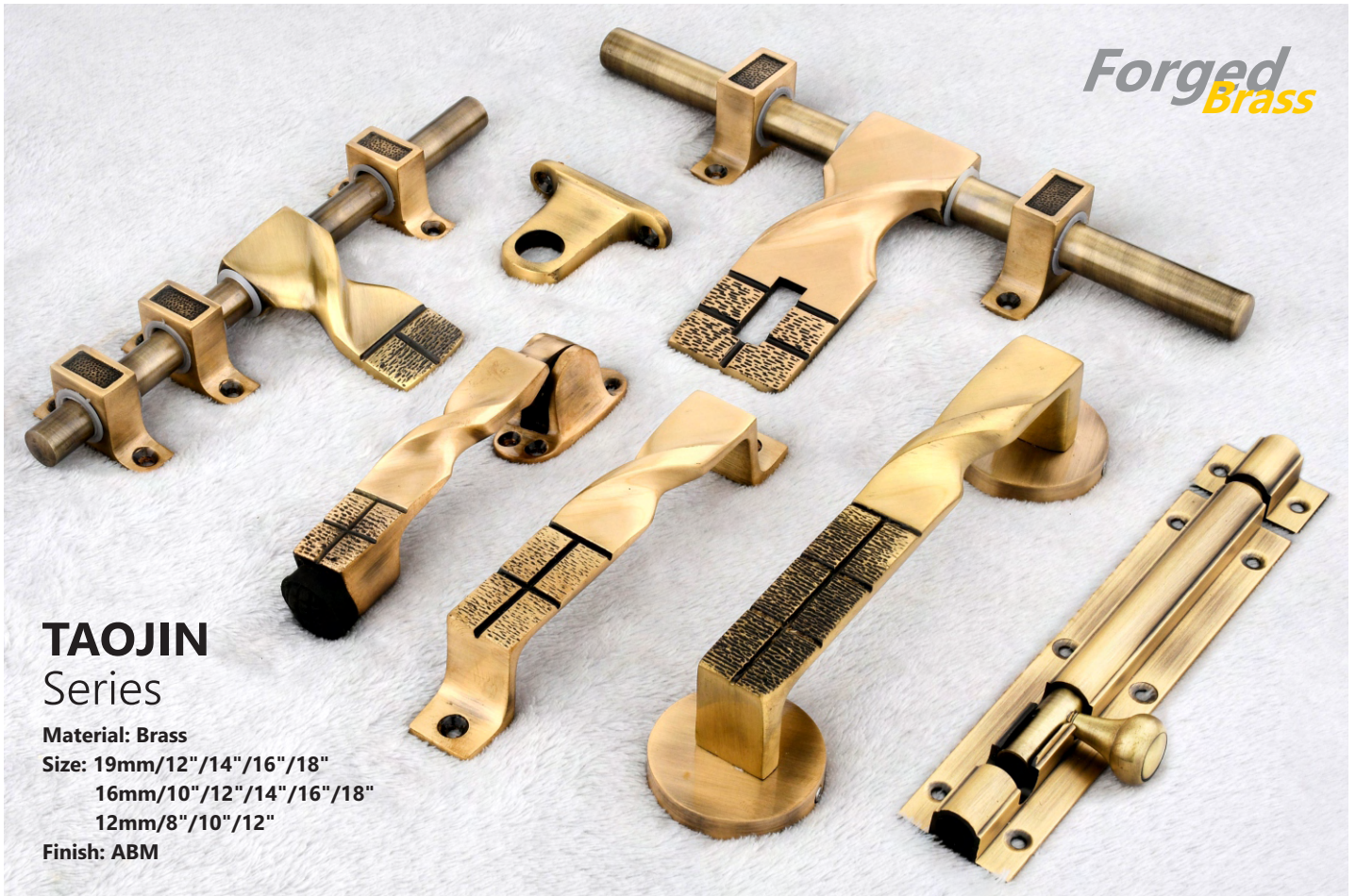

TAOJIN Series

Material: Brass

Size: 19mm/12"/14"/16"/18"

16mm/10"/12"/14"/16"/18"

12mm/8"/10"/12"

Finish: ABM

Brass Aldrop 16mm / 19mm		
Size	Packing / Box	MRP/Pc
16mm 10" (2+1)	1 Pc.	1780/-
16mm 10" (3+1)	1 Pc.	2020/-
16mm 12" (3+1)	1 Pc.	2090/-
16mm 14" (3+1)	1 Pc.	2170/-
19mm 12" (3+1)	1 Pc.	3890/-
19mm 14" (4+1)	1 Pc.	4280/-
19mm 16" (4+1)	1 Pc.	4360/-
19mm 18" (4+1)	1 Pc.	4450/-

Brass Aldrop 12mm		
Size	Packing / Box	MRP/Pc
12mm 8" (3+1)	2 Pc.	1240/-
12mm 10" (3+1)	2 Pc.	1280/-
12mm 12" (3+1)	2 Pc.	1320/-

Brass Latch 12mm \ 16mm		
Size	Packing / Box	MRP/Pc
12mm 8" (3)	2 Pc.	1040/-
12mm 10" (3)	2 Pc.	1075/-
12mm 12" (3)	2 Pc.	1110/-
16mm 10" (3)	2 Pc.	1450/-
16mm 12" (3)	2 Pc.	1520/-
16mm 14" (3)	2 Pc.	1600/-

Extra Cram		
Size	Packing / Box	MRP/Pc
12mm	10 Pc.	185/-

Extra Locking Kunda		
Size	Packing / Box	MRP/Pc
12mm	10 Pc.	185/-

Extra Cram		
Size	Packing / Box	MRP/Pc
16mm	10 Pc.	235/-
19mm	10 Pc.	300/-

Extra Locking Kunda		
Size	Packing / Box	MRP/Pc
16mm	10 Pc.	235/-
19mm	10 Pc.	300/-

Brass Pull Handle on Rose		
Size	Packing / Box	MRP/Pc
200mm	2 Pc.	1230/-
250mm	2 Pc.	1500/-

Brass Cabinet Handle (F/S)		
Size	Packing / Box	MRP/Pc
150mm	10 Pc.	410/-

Brass Stopper		
Size	Packing / Box	MRP/Pc
125mm	10 Pc.	550/-

Main Door Kit		
Size	Packing / Box	MRP/Set
16mm Single	1 Set	6250/-
16mm Double	1 Set	9850/-
19mm Single	1 Set	10100/-
19mm Double	1 Set	14930/-



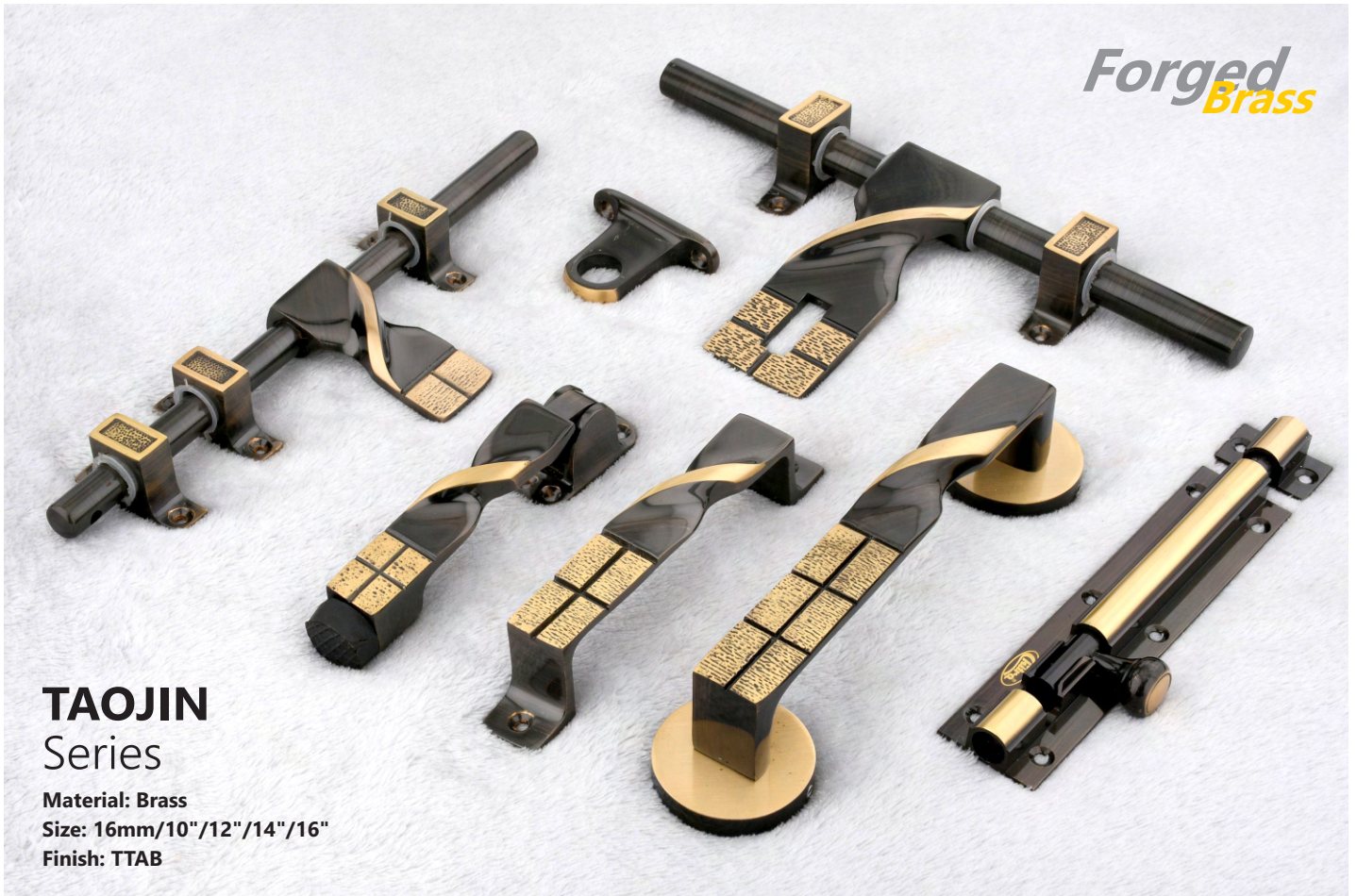

TAOJIN Series

Material: Brass
Size: 16mm/10"/12"/14"/16"
Finish: TTAB

Brass Aldrop 16mm / 19mm		
Size	Packing / Box	MRP/Pc
16mm 10" (2+1)	1 Pc.	1840/-
16mm 10" (3+1)	1 Pc.	2080/-
16mm 12" (3+1)	1 Pc.	2150/-
16mm 14" (3+1)	1 Pc.	2230/-
19mm 12" (3+1)	1 Pc.	3960/-
19mm 14" (4+1)	1 Pc.	4350/-
19mm 16" (4+1)	1 Pc.	4430/-
19mm 18" (4+1)	1 Pc.	4520/-

Brass Aldrop 12mm		
Size	Packing / Box	MRP/Pc
12mm 8" (3+1)	2 Pc.	1280/-
12mm 10" (3+1)	2 Pc.	1315/-
12mm 12" (3+1)	2 Pc.	1350/-

Brass Latch 12mm \ 16mm		
Size	Packing / Box	MRP/Pc
12mm 8" (3)	2 Pc.	1075/-
12mm 10" (3)	2 Pc.	1110/-
12mm 12" (3)	2 Pc.	1145/-
16mm 10" (3)	2 Pc.	1500/-
16mm 12" (3)	2 Pc.	1570/-
16mm 14" (3)	2 Pc.	1650/-

Extra Cram		
Size	Packing / Box	MRP/Pc
12mm	10 Pc.	190/-

Extra Locking Kunda		
Size	Packing / Box	MRP/Pc
12mm	10 Pc.	190/-

Extra Cram		
Size	Packing / Box	MRP/Pc
16mm	10 Pc.	250/-
19mm	10 Pc.	320/-

Extra Locking Kunda		
Size	Packing / Box	MRP/Pc
16mm	10 Pc.	250/-
19mm	10 Pc.	320/-

Brass Pull Handle on Rose		
Size	Packing / Box	MRP/Pc
200mm	2 Pc.	1230/-
250mm	2 Pc.	1500/-

Brass Cabinet Handle (F/S)		
Size	Packing / Box	MRP/Pc
150mm	10 Pc.	410/-

Brass Stopper		
Size	Packing / Box	MRP/Pc
125mm	10 Pc.	550/-

Main Door Kit		
Size	Packing / Box	MRP/Set
16mm Single	1 Set	6430/-
16mm Double	1 Set	10150/-
19mm Single	1 Set	10340/-
19mm Double	1 Set	15340/-





Locks & Hardware

BRASS DOOR KITS



CLOCK Series

Material: Brass
Size: 16mm/10"/12"/14"/16"
Finish: ABM

Brass Aldrop 16mm		
Size	Packing / Box	MRP/Pc
16mm 10" (2+1)	1 Pc.	1750/-
16mm 10" (3+1)	1 Pc.	1980/-
16mm 12" (3+1)	1 Pc.	2050/-
16mm 14" (3+1)	1 Pc.	2130/-

Extra Cram			Extra Locking Kunda		
Size	Packing / Box	MRP/Pc	Size	Packing / Box	MRP/Pc
16mm	10 Pc.	230/-	16mm	10 Pc.	230/-

Brass Pull Handle on Rose		
Size	Packing / Box	MRP/Pc
200mm	2 Pc.	1140/-
250mm	2 Pc.	1420/-

Main Door Kit		
Size	Packing / Box	MRP/Set
16mm Single	1 Set	5900/-
16mm Double	1 Set	9320/-

Brass Aldrop 12mm		
Size	Packing / Box	MRP/Pc
12mm 8" (3+1)	2 Pc.	1130/-
12mm 10" (3+1)	2 Pc.	1165/-
12mm 12" (3+1)	2 Pc.	1200/-

Brass Latch 12mm		
Size	Packing / Box	MRP/Pc
12mm 8" (3)	2 Pc.	985/-
12mm 10" (3)	2 Pc.	1020/-
12mm 12" (3)	2 Pc.	1055/-

Extra Cram			Extra Locking Kunda		
Size	Packing / Box	MRP/Pc	Size	Packing / Box	MRP/Pc
12mm	10 Pc.	175/-	12mm	10 Pc.	175/-

Brass Cabinet Handle (F/S)			Brass Stopper		
Size	Packing / Box	MRP/Pc	Size	Packing / Box	MRP/Pc
150mm	10 Pc.	355/-	125mm	10 Pc.	530/-





Locks & Hardware

BRASS DOOR KITS

Forged Brass



CLOCK Series

Material: Brass
Size: 16mm/10"/12"/14"/16"
Finish: TTAB

Brass Aldrop 16mm		
Size	Packing / Box	MRP/Pc
16mm 10" (2+1)	1 Pc.	1810/-
16mm 10" (3+1)	1 Pc.	2040/-
16mm 12" (3+1)	1 Pc.	2110/-
16mm 14" (3+1)	1 Pc.	2190/-

Extra Cram			Extra Locking Kunda		
Size	Packing / Box	MRP/Pc	Size	Packing / Box	MRP/Pc
16mm	10 Pc.	240/-	16mm	10 Pc.	240/-

Brass Pull Handle on Rose		
Size	Packing / Box	MRP/Pc
200mm	2 Pc.	1200/-
250mm	2 Pc.	1475/-

Main Door Kit		
Size	Packing / Box	MRP/Set
16mm Single	1 Set	6080/-
16mm Double	1 Set	9620/-

Brass Aldrop 12mm		
Size	Packing / Box	MRP/Pc
12mm 8" (3+1)	2 Pc.	1170/-
12mm 10" (3+1)	2 Pc.	1240/-
12mm 12" (3+1)	2 Pc.	1240/-

Brass Latch 12mm		
Size	Packing / Box	MRP/Pc
12mm 8" (3)	2 Pc.	1020/-
12mm 10" (3)	2 Pc.	1060/-
12mm 12" (3)	2 Pc.	1100/-

Extra Cram			Extra Locking Kunda		
Size	Packing / Box	MRP/Pc	Size	Packing / Box	MRP/Pc
12mm	10 Pc.	185/-	12mm	10 Pc.	185/-

Brass Cabinet Handle (F/S)			Brass Stopper		
Size	Packing / Box	MRP/Pc	Size	Packing / Box	MRP/Pc
150mm	10 Pc.	365/-	125mm	10 Pc.	550



Forged Brass



TISCO Series

Material: Brass
Size: 16mm/10"/12"/14"/16"
Finish: ABM

Brass Aldrop 16mm		
Size	Packing / Box	MRP/Pc
16mm 10" (2+1)	1 Pc.	1780/-
16mm 10" (3+1)	1 Pc.	2035/-
16mm 12" (3+1)	1 Pc.	2105/-
16mm 14" (3+1)	1 Pc.	2180/-

Extra Cram			Extra Locking Kunda		
Size	Packing / Box	MRP/Pc	Size	Packing / Box	MRP/Pc
16mm	10 Pc.	255/-	16mm	10 Pc.	235/-

Brass Pull Handle on Rose		
Size	Packing / Box	MRP/Pc
200mm	2 Pc.	1320/-
250mm	2 Pc.	1610/-

Main Door Kit		
Size	Packing / Box	MRP/Set
16mm Single	1 Set	6370/-
16mm Double	1 Set	10030/-

Brass Aldrop 12mm		
Size	Packing / Box	MRP/Pc
12mm 8" (3+1)	2 Pc.	1245/-
12mm 10" (3+1)	2 Pc.	1280/-
12mm 12" (3+1)	2 Pc.	1315/-

Brass Latch 12mm		
Size	Packing / Box	MRP/Pc
12mm 8" (3)	2 Pc.	1040/-
12mm 10" (3)	2 Pc.	1075/-
12mm 12" (3)	2 Pc.	1110/-

Extra Cram			Extra Locking Kunda		
Size	Packing / Box	MRP/Pc	Size	Packing / Box	MRP/Pc
12mm	10 Pc.	185/-	12mm	10 Pc.	185/-

Brass Cabinet Handle (F/S)			Brass Stopper		
Size	Packing / Box	MRP/Pc	Size	Packing / Box	MRP/Pc
150mm	10 Pc.	470/-	125mm	10 Pc.	530/-



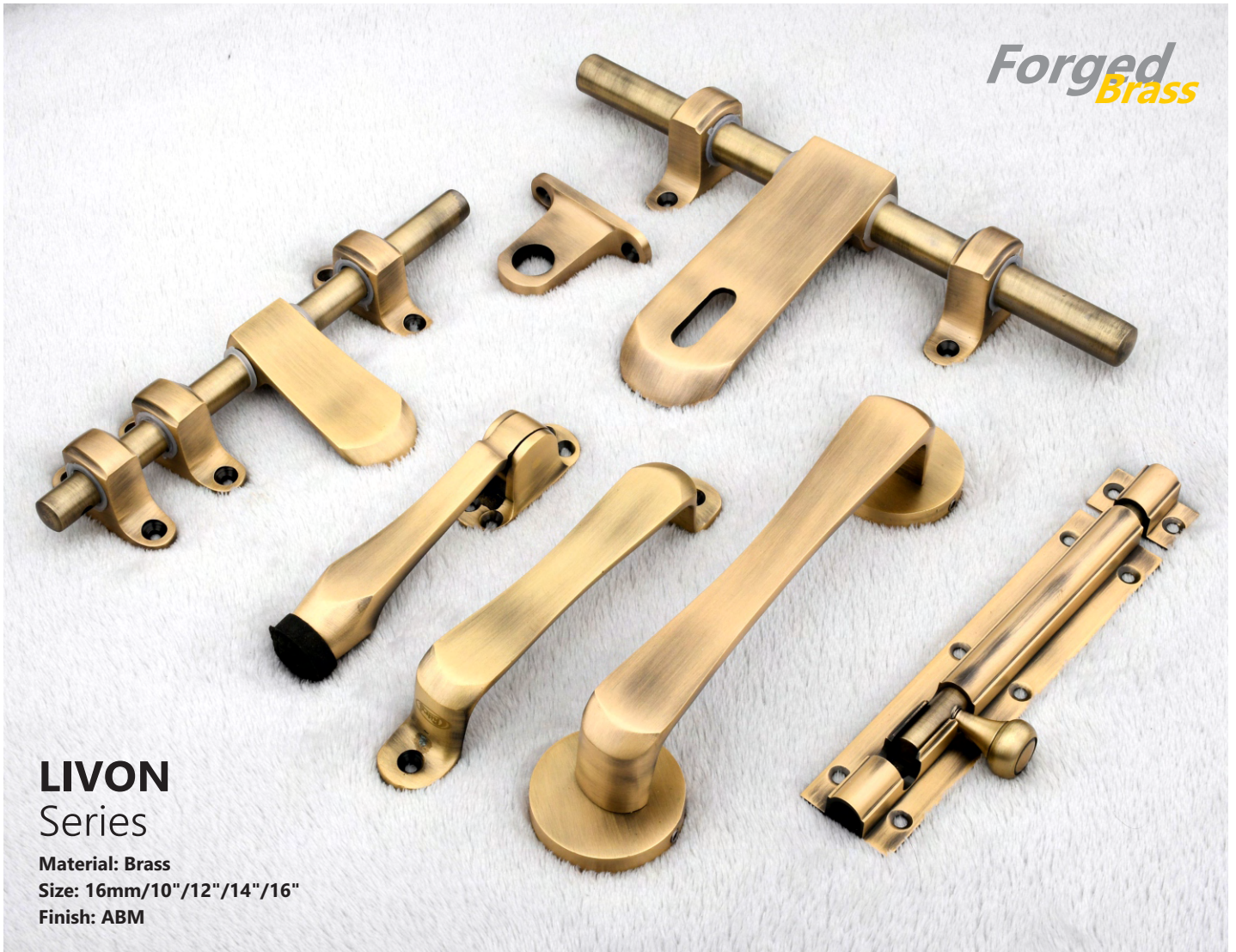

LIVON Series

Material: Brass

Size: 16mm/10"/12"/14"/16"

Finish: ABM

Brass Aldrop 16mm		
Size	Packing / Box	MRP/Pc
16mm 10" (2+1)	1 Pc.	1780/-
16mm 10" (3+1)	1 Pc.	2035/-
16mm 12" (3+1)	1 Pc.	2105/-
16mm 14" (3+1)	1 Pc.	2180/-

Extra Cram			Extra Locking Kunda		
Size	Packing / Box	MRP/Pc	Size	Packing / Box	MRP/Pc
16mm	10 Pc.	255/-	16mm	10 Pc.	235/-

Brass Pull Handle on Rose		
Size	Packing / Box	MRP/Pc
200mm	2 Pc.	1170/-
250mm	2 Pc.	1460/-

Main Door Kit		
Size	Packing / Box	MRP/Set
16mm Single	1 Set	6140/-
16mm Double	1 Set	9560/-

Brass Aldrop 12mm		
Size	Packing / Box	MRP/Pc
12mm 8" (3+1)	2 Pc.	1240/-
12mm 10" (3+1)	2 Pc.	1275/-
12mm 12" (3+1)	2 Pc.	1310/-

Brass Latch 12mm		
Size	Packing / Box	MRP/Pc
12mm 8" (3)	2 Pc.	1005/-
12mm 10" (3)	2 Pc.	1040/-
12mm 12" (3)	2 Pc.	1070/-

Extra Cram			Extra Locking Kunda		
Size	Packing / Box	MRP/Pc	Size	Packing / Box	MRP/Pc
12mm	10 Pc.	185/-	12mm	10 Pc.	185/-

Brass Cabinet Handle (F/S)			Brass Stopper		
Size	Packing / Box	MRP/Pc	Size	Packing / Box	MRP/Pc
150mm	10 Pc.	415/-	125mm	10 Pc.	530/-





ALTIS Series

Material: Brass

Size: 16mm/10"/12"/14"/16"

Finish: ABM

Brass Aldrop 16mm		
Size	Packing / Box	MRP/Pc
16mm 10" (2+1)	1 Pc.	1620/-
16mm 10" (3+1)	1 Pc.	1860/-
16mm 12" (3+1)	1 Pc.	1930/-
16mm 14" (3+1)	1 Pc.	2010/-

Extra Cram			Extra Locking Kunda		
Size	Packing / Box	MRP/Pc	Size	Packing / Box	MRP/Pc
16mm	10 Pc.	235/-	16mm	10 Pc.	235/-

Brass Pull Handle on Rose		
Size	Packing / Box	MRP/Pc
200mm	2 Pc.	1140/-
250mm	2 Pc.	1420/-

Main Door Kit		
Size	Packing / Box	MRP/Set
16mm Single	1 Set	5780/-
16mm Double	1 Set	9030/-

Brass Aldrop 12mm		
Size	Packing / Box	MRP/Pc
12mm 8" (3+1)	2 Pc.	1135/-
12mm 10" (3+1)	2 Pc.	1170/-
12mm 12" (3+1)	2 Pc.	1205/-

Brass Latch 12mm		
Size	Packing / Box	MRP/Pc
12mm 8" (3)	2 Pc.	945/-
12mm 10" (3)	2 Pc.	980/-
12mm 12" (3)	2 Pc.	1015/-

Extra Cram			Extra Locking Kunda		
Size	Packing / Box	MRP/Pc	Size	Packing / Box	MRP/Pc
12mm	10 Pc.	185/-	12mm	10 Pc.	185/-

Brass Cabinet Handle (F/S)			Brass Stopper		
Size	Packing / Box	MRP/Pc	Size	Packing / Box	MRP/Pc
150mm	10 Pc.	330/-	125mm	10 Pc.	530/-





Locks & Hardware

zinc door kits





HERCULES Series

Material: Zinc

Size: 16mm/8"/10"/12"/14"
12mm/8"/10"/12"

Finish: AB

Zinc Aldrop 16mm		
Size	Packing / Box	MRP/Pc
16mm 8" (3+1)	1 Pc.	1590/-
16mm 10" (2+1)	1 Pc.	1445/-
16mm 10" (3+1)	1 Pc.	1650/-
16mm 12" (3+1)	1 Pc.	1720/-
16mm 14" (3+1)	1 Pc.	1790/-

Zinc Latch 12mm		
Size	Packing / Box	MRP/Pc
12mm 8" (3)	2 Pc.	1020/-
12mm 10" (3)	2 Pc.	1065/-
12mm 12" (3)	2 Pc.	1110/-

Zinc Pull Handle on Rose		
Size	Packing / Box	MRP/Pc
225mm	2 Pc.	1005/-

Extra Cram			Extra Locking Kunda		
Size	Packing / Box	MRP/Pc	Size	Packing / Box	MRP/Pc
16mm	2 Pc.	205/-	16mm	2 Pc.	205/-

Zinc Cabinet Handle (F/S)		
Size	Packing / Box	MRP/Pc
150mm	10 Pc.	360/-

Main Door Kit		
Size	Packing / Box	MRP/Set
16mm Single	1 Set	4600/-
16mm Double	1 Set	6960/-

Zinc Stopper (F/S)		
Size	Packing / Box	MRP/Pc
125mm	10 Pc.	415/-





BASCON Series

Material: Zinc

Size: 16mm/8"/10"/12"/14"

Finish: AB

Zinc Aldrop 16mm		
Size	Packing / Box	MRP/Pc
16mm 8" (3+1)	1 Pc.	1650/-
16mm 10" (2+1)	1 Pc.	1490/-
16mm 10" (3+1)	1 Pc.	1710/-
16mm 12" (3+1)	1 Pc.	1780/-
16mm 14" (3+1)	1 Pc.	1850/-

Zinc Latch 12mm		
Size	Packing / Box	MRP/Pc
12mm 8" (3)	2 Pc.	1050/-
12mm 10" (3)	2 Pc.	1095/-
12mm 12" (3)	2 Pc.	1140/-

Zinc Pull Handle on Rose		
Size	Packing / Box	MRP/Pc
225mm	2 Pc.	770/-

Extra Cram			Extra Locking Kunda		
Size	Packing / Box	MRP/Pc	Size	Packing / Box	MRP/Pc
16mm	2 Pc.	185/-	16mm	2 Pc.	220/-

Zinc Cabinet Handle (F/S)		
Size	Packing / Box	MRP/Pc
150mm	10 Pc.	350/-

Main Door Kit		
Size	Packing / Box	MRP/Set
16mm Single	1 Set	4420/-
16mm Double	1 Set	6610/-

Zinc Stopper (F/S)		
Size	Packing / Box	MRP/Pc
125mm	10 Pc.	425/-





BASCON Series

Material: Zinc

Size: 16mm/8"/10"/12"/14"

Finish: NS

Zinc Aldrop 16mm		
Size	Packing / Box	MRP/Pc
16mm 8" (3+1)	1 Pc.	1590/-
16mm 10" (2+1)	1 Pc.	1445/-
16mm 10" (3+1)	1 Pc.	1650/-
16mm 12" (3+1)	1 Pc.	1720/-
16mm 14" (3+1)	1 Pc.	1790/-

Zinc Latch 12mm		
Size	Packing / Box	MRP/Pc
12mm 8" (3)	2 Pc.	1015/-
12mm 10" (3)	2 Pc.	1060/-
12mm 12" (3)	2 Pc.	1105/-

Zinc Pull Handle on Rose		
Size	Packing / Box	MRP/Pc
225mm	2 Pc.	720/-

Extra Cram			Extra Locking Kunda		
Size	Packing / Box	MRP/Pc	Size	Packing / Box	MRP/Pc
16mm	2 Pc.	205/-	16mm	2 Pc.	205/-

Zinc Cabinet Handle (F/S)		
Size	Packing / Box	MRP/Pc
150mm	10 Pc.	330/-

Main Door Kit		
Size	Packing / Box	MRP/Set
16mm Single	1 Set	4310/-
16mm Double	1 Set	6370/-

Zinc Stopper (F/S)		
Size	Packing / Box	MRP/Pc
125mm	10 Pc.	400/-





DICE Series

Material: Zinc

Size: 16mm/8"/10"/12"/14"

Finish: AB

Zinc Aldrop 16mm		
Size	Packing / Box	MRP/Pc
16mm 8" (3+1)	1 Pc.	1640/-
16mm 10" (2+1)	1 Pc.	1475/-
16mm 10" (3+1)	1 Pc.	1700/-
16mm 12" (3+1)	1 Pc.	1760/-
16mm 14" (3+1)	1 Pc.	1830/-

Zinc Latch 12mm		
Size	Packing / Box	MRP/Pc
12mm 8" (3)	2 Pc.	1090/-
12mm 10" (3)	2 Pc.	1135/-
12mm 12" (3)	2 Pc.	1180/-

Zinc Pull Handle on Rose		
Size	Packing / Box	MRP/Pc
225mm	2 Pc.	815/-

Extra Cram			Extra Locking Kunda		
Size	Packing / Box	MRP/Pc	Size	Packing / Box	MRP/Pc
16mm	2 Pc.	225/-	16mm	2 Pc.	225/-

Zinc Cabinet Handle (F/S)		
Size	Packing / Box	MRP/Pc
150mm	10 Pc.	360/-

Main Door Kit		
Size	Packing / Box	MRP/Set
16mm Single	1 Set	4480/-
16mm Double	1 Set	6610/-

Zinc Stopper (F/S)		
Size	Packing / Box	MRP/Pc
125mm	10 Pc.	425/-



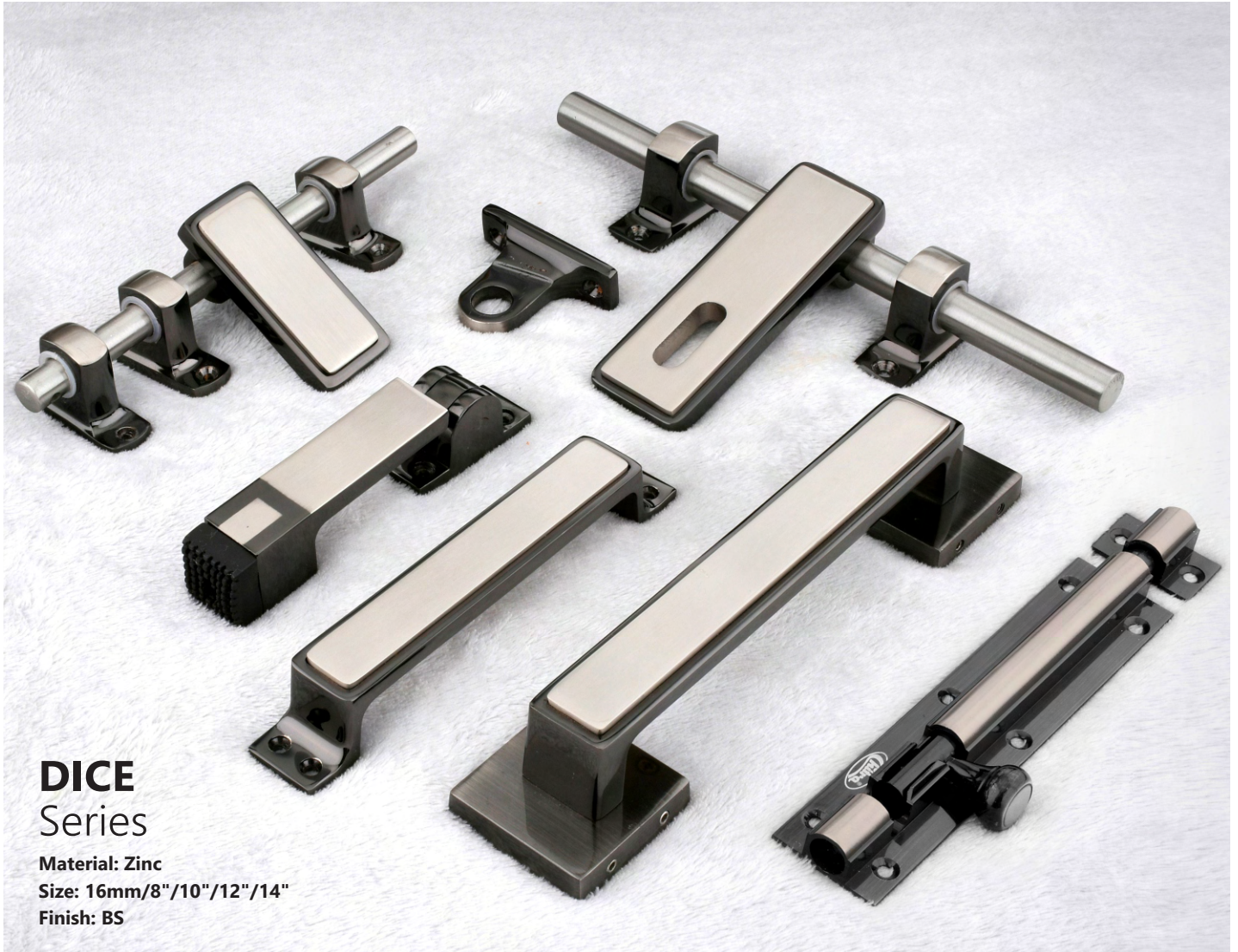

DICE Series

Material: Zinc

Size: 16mm/8"/10"/12"/14"

Finish: BS

Zinc Aldrop 16mm		
Size	Packing / Box	MRP/Pc
16mm 8" (3+1)	1 Pc.	1640/-
16mm 10" (2+1)	1 Pc.	1475/-
16mm 10" (3+1)	1 Pc.	1700/-
16mm 12" (3+1)	1 Pc.	1760/-
16mm 14" (3+1)	1 Pc.	1830/-

Zinc Latch 12mm		
Size	Packing / Box	MRP/Pc
12mm 8" (3)	2 Pc.	1090/-
12mm 10" (3)	2 Pc.	1135/-
12mm 12" (3)	2 Pc.	1180/-

Zinc Pull Handle on Rose		
Size	Packing / Box	MRP/Pc
225mm	2 Pc.	815/-

Extra Cram			Extra Locking Kunda		
Size	Packing / Box	MRP/Pc	Size	Packing / Box	MRP/Pc
16mm	2 Pc.	225/-	16mm	2 Pc.	225/-

Zinc Cabinet Handle (F/S)		
Size	Packing / Box	MRP/Pc
150mm	10 Pc.	360/-

Main Door Kit		
Size	Packing / Box	MRP/Set
16mm Single	1 Set	4480/-
16mm Double	1 Set	6610/-

Zinc Stopper (F/S)		
Size	Packing / Box	MRP/Pc
125mm	10 Pc.	425/-





JAMES Series

Material: Zinc

Size: 16mm/8"/10"/12"/14"

Finish: AB

Zinc Aldrop 16mm		
Size	Packing / Box	MRP/Pc
16mm 8" (3+1)	1 Pc.	1680/-
16mm 10" (2+1)	1 Pc.	1530/-
16mm 10" (3+1)	1 Pc.	1730/-
16mm 12" (3+1)	1 Pc.	1800/-
16mm 14" (3+1)	1 Pc.	1870/-

Zinc Latch 12mm		
Size	Packing / Box	MRP/Pc
12mm 8" (3)	2 Pc.	1125/-
12mm 10" (3)	2 Pc.	1170/-
12mm 12" (3)	2 Pc.	1215/-

Zinc Pull Handle on Rose		
Size	Packing / Box	MRP/Pc
225mm	2 Pc.	980/-

Extra Cram			Extra Locking Kunda		
Size	Packing / Box	MRP/Pc	Size	Packing / Box	MRP/Pc
16mm	2 Pc.	210/-	16mm	2 Pc.	210/-

Zinc Cabinet Handle (F/S)		
Size	Packing / Box	MRP/Pc
150mm	10 Pc.	450/-

Main Door Kit		
Size	Packing / Box	MRP/Set
16mm Single	1 Set	4960/-
16mm Double	1 Set	7080/-

Zinc Stopper (F/S)		
Size	Packing / Box	MRP/Pc
125mm	10 Pc.	470/-





JAMES Series

Material: Zinc

Size: 16mm/8"/10"/12"/14"

Finish: BS

Zinc Aldrop 16mm		
Size	Packing / Box	MRP/Pc
16mm 8" (3+1)	1 Pc.	1680/-
16mm 10" (2+1)	1 Pc.	1530/-
16mm 10" (3+1)	1 Pc.	1730/-
16mm 12" (3+1)	1 Pc.	1800/-
16mm 14" (3+1)	1 Pc.	1870/-

Zinc Latch 12mm		
Size	Packing / Box	MRP/Pc
12mm 8" (3)	2 Pc.	1125/-
12mm 10" (3)	2 Pc.	1170/-
12mm 12" (3)	2 Pc.	1215/-

Zinc Pull Handle on Rose		
Size	Packing / Box	MRP/Pc
225mm	2 Pc.	980/-

Extra Cram			Extra Locking Kunda		
Size	Packing / Box	MRP/Pc	Size	Packing / Box	MRP/Pc
16mm	2 Pc.	210/-	16mm	2 Pc.	210/-

Zinc Cabinet Handle (F/S)		
Size	Packing / Box	MRP/Pc
150mm	10 Pc.	450/-

Main Door Kit		
Size	Packing / Box	MRP/Set
16mm Single	1 Set	4960/-
16mm Double	1 Set	7080/-

Zinc Stopper (F/S)		
Size	Packing / Box	MRP/Pc
125mm	10 Pc.	470/-





Locks & Hardware



stainless
steel
door kits



Locks & Hardware

Stainless Steel DOOR KITS



WAVE

Material: Stainless Steel
Size: 16mm/8"/10"/12" | 14mm/8"/10"
Finish: SS

SS Cabinet Handle F/S 3mm		
Size	Packing / Box	MRP/Pc
150mm	12 Pc.	67

SS Cabinet Handle F/S 5mm		
Size	Packing / Box	MRP/Pc
150mm	10 Pc.	135
200mm	10 Pc.	170

SS Aldrop 5mm Heavy Cram		
Size	Packing / Box	MRP/Pc
16mm 8" (3+1)	2 Pc.	620/-
16mm 10" (2+1)	2 Pc.	620/-
16mm 10" (3+1)	2 Pc.	660/-
16mm 12" (3+1)	2 Pc.	695/-

SS Aldrop 3mm Heavy Cram		
Size	Packing / Box	MRP/Pc
14mm 8" (2+1)	4 Pc.	355/-
14mm 8" (3+1)	4 Pc.	390/-
14mm 10" (3+1)	2 Pc.	425/-

SS Stopper Leg		
Size	Packing / Box	MRP/Pc
125mm	8 Pc.	124

Main Door Kit		
Size	Packing / Box	MRP/Set
16mm x 10" Single	1 Set	1655/-
16mm x 12" Double	1 Set	2480/-



WAVE

Material: Stainless Steel
Size: 16mm/8"/10"/12" | 14mm/8"/10"
Finish: AM

SS Cabinet Handle F/S 3mm		
Size	Packing / Box	MRP/Pc
150mm	12 Pc.	104/-

SS Cabinet Handle F/S 5mm		
Size	Packing / Box	MRP/Pc
150mm	10 Pc.	171/-
200mm	10 Pc.	219/-

SS Aldrop 5mm Heavy Cram		
Size	Packing / Box	MRP/Pc
16mm 8" (3+1)	2 Pc.	710/-
16mm 10" (2+1)	2 Pc.	710/-
16mm 10" (3+1)	2 Pc.	770/-
16mm 12" (3+1)	2 Pc.	830/-

SS Aldrop 3mm Heavy Cram		
Size	Packing / Box	MRP/Pc
14mm 8" (2+1)	4 Pc.	445/-
14mm 8" (3+1)	4 Pc.	480/-
14mm 10" (3+1)	2 Pc.	530/-

SS Stopper Leg		
Size	Packing / Box	MRP/Pc
125mm	8 Pc.	156/-

Main Door Kit		
Size	Packing / Box	MRP/Set
16mm x 10" Single	1 Set	1950/-
16mm x 12" Double	1 Set	2890/-





Locks & Hardware

Stainless Steel DOOR KITS



WAVE

Material: Stainless Steel
Size: 16mm/8"/10"/12" | 14mm/8"/10"
Finish: AB

SS Cabinet Handle F/S 3mm		
Size	Packing / Box	MRP/Pc
150mm	12 Pc.	104/-

SS Cabinet Handle F/S 5mm		
Size	Packing / Box	MRP/Pc
150mm	10 Pc.	171/-
200mm	10 Pc.	219/-

SS Aldrop 5mm Heavy Cram		
Size	Packing / Box	MRP/Pc
16mm 8" (3+1)	2 Pc.	710/-
16mm 10" (2+1)	2 Pc.	710/-
16mm 10" (3+1)	2 Pc.	770/-
16mm 12" (3+1)	2 Pc.	830/-

SS Aldrop 3mm Heavy Cram		
Size	Packing / Box	MRP/Pc
14mm 8" (2+1)	4 Pc.	445/-
14mm 8" (3+1)	4 Pc.	480/-
14mm 10" (3+1)	2 Pc.	530/-

SS Stopper Leg		
Size	Packing / Box	MRP/Pc
125mm	8 Pc.	156/-

Main Door Kit		
Size	Packing / Box	MRP/Set
16mm x 10" Single	1 Set	1950/-
16mm x 12" Double	1 Set	2890/-



WAVE

Material: Stainless Steel
Size: 16mm/8"/10"/12" | 14mm/8"/10"
Finish: BM

SS Cabinet Handle F/S 3mm		
Size	Packing / Box	MRP/Pc
150mm	12 Pc.	104/-

SS Cabinet Handle F/S 5mm		
Size	Packing / Box	MRP/Pc
150mm	10 Pc.	171/-
200mm	10 Pc.	219/-

SS Aldrop 5mm Heavy Cram		
Size	Packing / Box	MRP/Pc
16mm 8" (2+1)	1 Pc.	710/-
16mm 10" (2+1)	1 Pc.	710/-
16mm 10" (3+1)	1 Pc.	770/-
16mm 12" (3+1)	1 Pc.	830/-

SS Aldrop 3mm Heavy Cram		
Size	Packing / Box	MRP/Pc
14mm 8" (2+1)	4 Pc.	445/-
14mm 8" (3+1)	4 Pc.	480/-
14mm 10" (3+1)	2 Pc.	530/-

SS Stopper Leg		
Size	Packing / Box	MRP/Pc
125mm	8 Pc.	156/-

Main Door Kit		
Size	Packing / Box	MRP/Pc
16mm x 10" Single	1 Set	1950/-
16mm x 12" Double	1 Set	2890/-





Locks & Hardware

Stainless Steel DOOR KITS



MAT FLOWER

Material: Stainless Steel
Size: 14mm/8"/10"
Finish: SS

SS Cabinet Handle F/S 3mm		
Size	Packing / Box	MRP/PC
150mm	12 Pc.	78/-

SS Cabinet Handle F/S 5mm		
Size	Packing / Box	MRP/PC
150mm	10 Pc.	145/-
200mm	10 Pc.	181/-

SS Aldrop 5mm Heavy Cram		
Size	Packing / Box	MRP/Pc
16mm 8" (3+1)	2 Pc.	640/-
16mm 10" (2+1)	2 Pc.	640/-
16mm 10" (3+1)	2 Pc.	685/-
16mm 12" (3+1)	2 Pc.	720/-

SS Aldrop 3mm Heavy Cram		
Size	Packing / Box	MRP/PC
14mm 8" (2+1)	4 Pc.	375/-
14mm 8" (3+1)	4 Pc.	410/-
14mm 10" (3+1)	2 Pc.	445/-

Main Door Kit		
Size	Packing / Box	MRP/Set
16mm x 10" Single	1 Set	1770/-
16mm x 12" Double	1 Set	2655/-

SS Stopper Leg		
Size	Packing / Box	MRP/PC
125mm	8 Pc.	124/-



MAT FLOWER

Material: Stainless Steel
Size: 16mm/8"/10"/12" | 14mm/8"/10"
Finish: AM

SS Cabinet Handle F/S 3mm		
Size	Packing / Box	MRP/PC
150mm	12 Pc.	104/-

SS Cabinet Handle F/S 5mm		
Size	Packing / Box	MRP/PC
150mm	10 Pc.	171/-
200mm	10 Pc.	219/-

SS Aldrop 5mm Heavy Cram		
Size	Packing / Box	MRP/Pc
16mm 8" (3+1)	2 Pc.	710/-
16mm 10" (2+1)	2 Pc.	710/-
16mm 10" (3+1)	2 Pc.	770/-
16mm 12" (3+1)	2 Pc.	830/-

SS Aldrop 3mm Heavy Cram		
Size	Packing / Box	MRP/PC
14mm 8" (2+1)	4 Pc.	445/-
14mm 8" (3+1)	4 Pc.	480/-
14mm 10" (3+1)	2 Pc.	530/-

SS Stopper Leg		
Size	Packing / Box	MRP/PC
125mm	8 Pc.	156/-

Main Door Kit		
Size	Packing / Box	MRP/Set
16mm x 10" Single	1 Set	1950/-
16mm x 12" Double	1 Set	2890/-





Locks & Hardware

Stainless Steel ALDROP

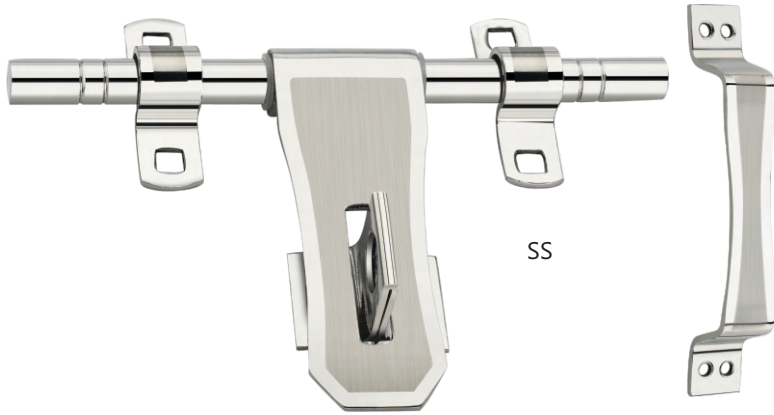

SS

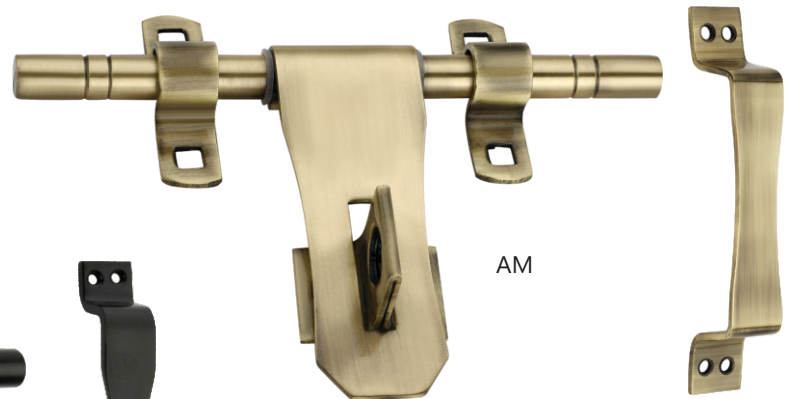

AM

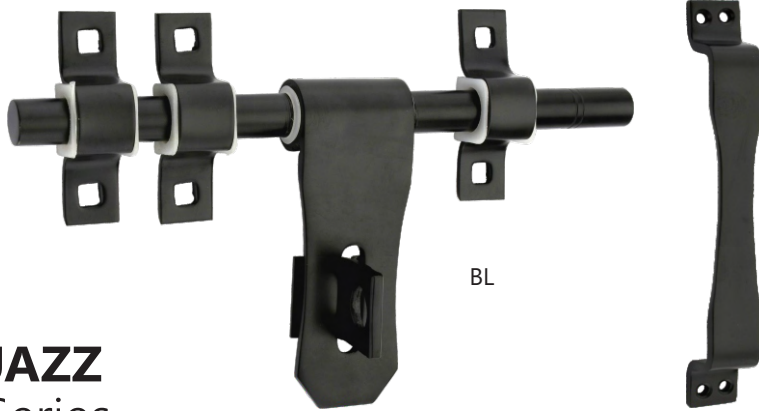

BL

JAZZ Series

Material: Stainless Steel

Size: 16mm/10"/12"

Finish: AB, BM

SS Aldrop 5mm Heavy Cram

Size	Packing / Box	MRP/Pc	
		SS	AB/BM
16mm 10" (2+1)	2 Pc.	620/-	710/-
16mm 10" (3+1)	2 Pc.	660/-	770/-
16mm 12" (3+1)	2 Pc.	695/-	830/-

SS Cabinet Handle F/S 3mm

Size	Packing / Box	MRP/Pc	
		SS	AB/BM
150mm	12 Pc.	67/-	104/-

SS Aldrop 3mm Heavy Cram

Size	Packing / Box	MRP/Pc	
		SS	AB/BM
14mm 8" (2+1)	1 Pc.	355/-	445/-
14mm 8" (3+1)	1 Pc.	390/-	480/-
14mm 10" (3+1)	1 Pc.	425/-	530/-

SS Cabinet Handle F/S 5mm

Size	Packing / Box	MRP/Pc	
		SS	AB/BM
150mm	10 Pc.	135/-	171/-
200mm	10Pc.	170/-	219/-



BRASS CABINET HANDLES

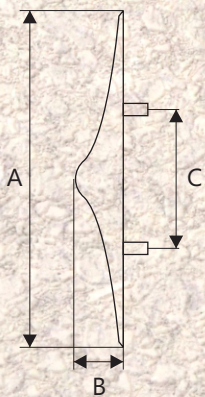

CH 08 - Seashell

Material: Brass
 Finish: ABM / BM / FG / RG
 Description: Cabinet Handle

Cabinet Knob

Size (mm / Inch)			MRP / PC	
A	B	C	BM / ABM	FG / RG
75 / 3	25	-	355/-	390/-
100 / 4	38	60	590/-	650/-

Cabinet Handle

Size (mm / Inch)			MRP / PC	
A	B	C	BM / ABM	FG / RG
150 / 6	25	72	530/-	590/-
200 / 8	25	96	770/-	845/-
225 / 19	25	128	825/-	910/-
300 / 12	38	160	1240/-	1370/-
450 / 18	38	224	2005/-	2220/-





CH 01 - Bronex

Finish: ABM / BM NSM / FG / RG



CH 04 - Orco

Finish: ABM / BM NSM / FG / RG

Size	Packing/Box	MRP/Pc	
		NSM /ABM/ BM	FG/RG
96mm	10 Pc.	385/-	422/-
128mm	10 Pc.	549/-	603/-
160mm	10 Pc.	841/-	925/-
224mm	10 Pc.	1097/-	1207/-

Size	Packing/Box	MRP/Pc	
		NSM /ABM/BM	FG/RG
96mm	10 Pc.	230/-	260/-
128mm	10 Pc.	348/-	389/-
160mm	10 Pc.	596/-	661/-
224mm	10 Pc.	926/-	1027/-



CH 02 - Scarlett

Finish: ABM / BM NSM / FG / RG



CH 03 - Taylor

Finish: ABM / BM NSM / FG / RG

Size	Packing/Box	MRP/Pc	
		NSM /ABM/ BM	FG/RG
96mm	10 Pc.	301/-	325/-
128mm	10 Pc.	348/-	384/-
160mm	10 Pc.	513/-	572/-
224mm	10 Pc.	620/-	714/-

Size	Packing/Box	MRP/Pc	
		NSM /ABM/ BM	FG/RG
96mm	10 Pc.	313/-	342/-
128mm	10 Pc.	490/-	531/-
160mm	10 Pc.	726/-	791/-
224mm	10 Pc.	903/-	1003/-





Locks & Hardware

BRASS CABINET KNOBS



PU 01 - Mona

Finish: ABM / BM / NSM / FG / RG

Size	Packing/Box	MRP/Pc	
		BM / NSM / ABM	FG
32x19mm	12 Pc.	330/-	380/-



PU 02 - Lisa

Finish: ABM / BM / NSM / FG / RG

Size	Packing/Box	MRP/Pc	
		BM / NSM / ABM	FG/RG
50x12mm	12 Pc.	235/-	260/-



PU 05 - Simona

Finish: ABM / BM / NSM / FG / RG

Size	Packing/Box	MRP/Pc	
		ABM / BM	PVD FG / RG
25mm	10 Pc.	315/-	340/-



PU 06 - Sun Flora

Finish: ABM / BM / NSM / FG / RG

Size	Packing/Box	MRP/Pc	
		ABM / BM	PVD FG / RG
25mm	10 Pc.	425/-	495/-



PU 07 - Inline

Finish: ABM / BM / NSM / FG / RG

Size	Packing/Box	MRP/Pc	
		ABM-BM / PVD	RG-BM
25mm	10 Pc.	765/-	



PU 04 - Halfmoon

Finish: ABM / BM / NSM / FG / RG

Size	Packing/Box	MRP/Pc	
		ABM/ BM / BGC	
50x25mm	12 Pc.	355/-	





Locks & Hardware

SLIDING WARDROBE HANDLE



CHZ 05 - Slim Concealed Handle

Material: Aluminum
Finish: Silk Black
Description: Cabinet Handle

Size	Packing/Box	MRP/Pc SILK BLACK
12"	15 Pc.	640/-
18"	15 Pc.	955/-
24"	15 Pc.	1275/-
36"	10 Pc.	2125/-



CHZ 04 - Concealed Flush Handle

Material: Zinc
Finish: AB GOLD/ RGM/ BTT
Description: Cabinet Handle

Size	Packing/Box	MRP/Pc RG/BM/AB-GOLD
98mm	10 Pc.	365/-
160mm	10 Pc.	580/-
224mm	10 Pc.	825/-
288mm	10 Pc.	1000/-

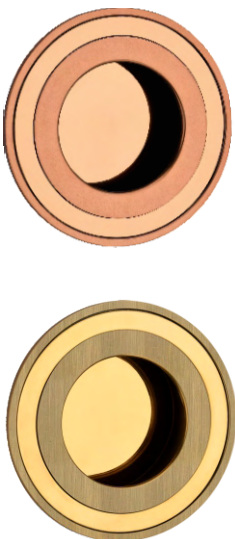
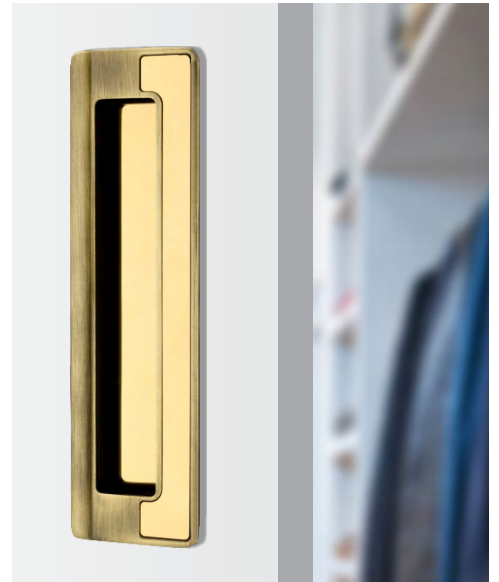

CHZ 010 - Round Flush Handle

Material: Zinc
Finish: ROSE GOLD/AB GOLD/BLACK
Description: Cabinet Handle

Size	Packing/Box	MRP/Pc ROSE GOLD/AB GOLD/BLACK
75mm	10 Pc.	340/-





Locks & Hardware

WARDROBE

PULL HANDLE



CHZ 06 Sleek Long

Material: Aluminum
Finish: Silk Black / Rose Gold
Description: Cabinet Handle

Size	Packing/Box	MRP/Pc SILK BLACK/RG
12"	15 Pc.	555 /-
18"	15 Pc.	830 /-
24"	15 Pc.	1120/-
36"	10 Pc.	1710/-

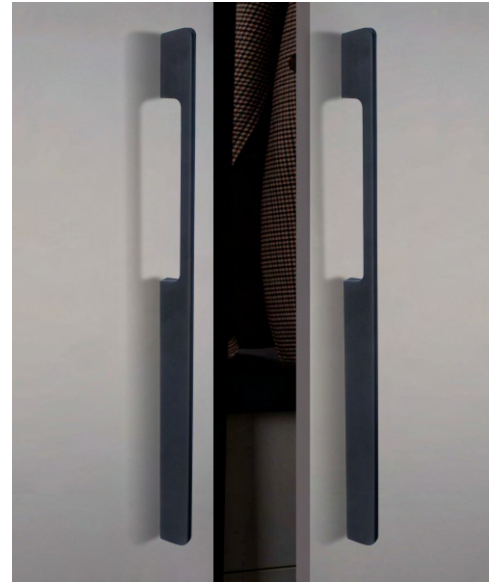

CHZ 09 - Curvy

Material: Zinc
Finish: RG/BM
Description: Cabinet Handle

Size	Packing/Box	MRP/Pc RG/BM
96mm	10 Pc.	220/-
160mm	10 Pc.	385/-
224mm	10 Pc.	530/-
288mm	10 Pc.	720/-



CHS 01 - Nord

Material: Stainless Steel
Finish: AB/BM/PVD FG/RG
Description: Cabinet Handle

Size	Packing/Box	MRP/Pc	
		AB/BM	PVD FG/RG
96mm	10 Pc.	470/-	535/-
128mm	10 Pc.	580/-	660/-
160mm	10 Pc.	740/-	850/-
224mm	10 Pc.	895/-	1040/-
288mm	10 Pc.	1170/-	1345/-





Locks & Hardware

DRAWER HANDLES & KNOBS



CHZ 03 - Profile

Material: Zinc
Finish: RGM/BM
Description: Cabinet Handle

Size(mm)	Packing/Box	MRP/ Pc RGM/BM
8" / 200mm	15 Pc.	208/-
12" / 300mm	15 Pc.	312/-
16" / 400mm	15 Pc.	416/-
20" / 500mm	15 Pc.	520/-
24" / 600mm	15 Pc.	720/-
30" / 750mm	15 Pc.	1080/-
36" / 900mm	15 Pc.	1494/-



CHZ 07 - Chest Handle

Material: Zinc
Finish: ABM / NSM/ BM
Description: Cabinet Handle

Size	Packing/Box	MRP/Pc ABM/NSM/BM
4"	10 Pc.	330/-

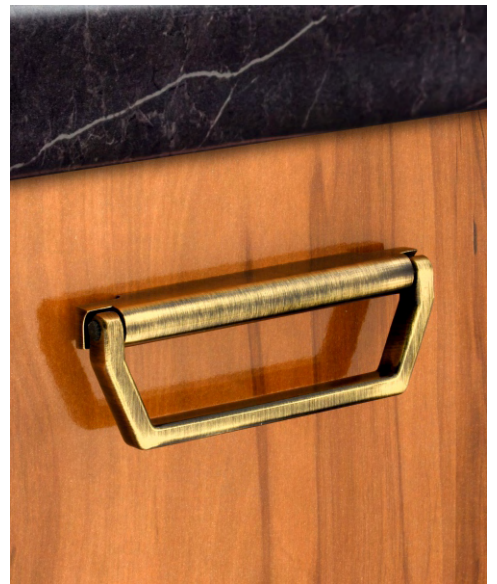

ALUMINUM KNOBS



CKA 01 - Pound

Material: Aluminium
Finish: AB/BM/PVD-FG/RG
Description: Cabinet Knob

Size	Packing/Box	MRP/Pc AB/BM/PVD-FG/RG
25x25mm	12 Pc.	155/-



CKA 02 - Knary

Material: Aluminium
Finish: AB/BM/PVD-FG/RG
Description: Cabinet Knob

Size	Packing/Box	MRP/Pc AB/BM/PVD-FG/RG
25x25mm	12 Pc.	165/-





**CKS 01
Flow** | Material: SS 304
Finish: SS/AB/BM/RG
Description: Cabinet Knob

Size	Packing/Box	MRP/Pc SS/AB/BM/RG
38x38mm	12 Pc.	250/-



**CKS 02
Leaf** | Material: SS 304
Finish: SS/AB/BM/RG
Description: Cabinet Knob

Size	Packing/Box	MRP/Pc SS/AB/BM/RG
50x50mm	12 Pc.	320/-



**CKS 03
Flower** | Material: SS 304
Finish: SS/AB/BM/RG
Description: Cabinet Knob

Size	Packing/Box	MRP/Pc SS/AB/BM/RG
52x52mm	12 Pc.	320/-



**CKS 04
Surya** | Material: SS 304
Finish: SS/AB/BM/RG
Description: Cabinet Knob

Size	Packing/Box	MRP/Pc SS/AB/BM/RG
40x40mm	12 Pc.	250/-



**CKS 05
Kamal** | Material: SS 304
Finish: SS/AB/BM/RG
Description: Cabinet Knob

Size	Packing/Box	MRP/Pc SS/AB/BM/RG
50x50mm	12 Pc.	320/-





Locks & Hardware

DOOR STOPPERS



BS 16 - Bumper

Material: Brass
Finish: AB / NS
Description: Door Stopper

Size	Packing/Box	MRP/Pc
125mm	5 Pc.	710/-
150mm	4 Pc.	885/-

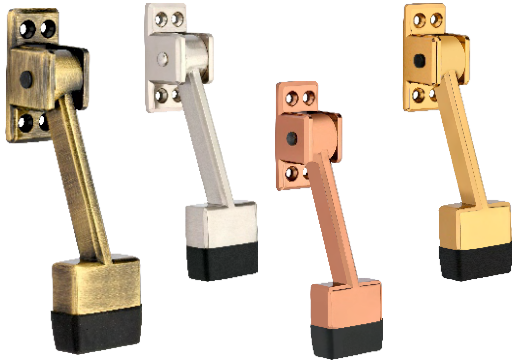

ZS 11 - Panama

Material: Zinc
Finish: RG / NS / AB / Gold/BM
Description: Door Stopper

Size	Packing/Box	MRP/Pc	
		SS/AB/BL	RG/FG
125mm	10 Pc.	400/-	425/-



ZS 13 - Kick Down Door Stopper

Material: Zinc
Finish: SS / AB
Description: Door Stopper

Size	Packing/Box	MRP/Pc
130mm	10 Pc.	505/-

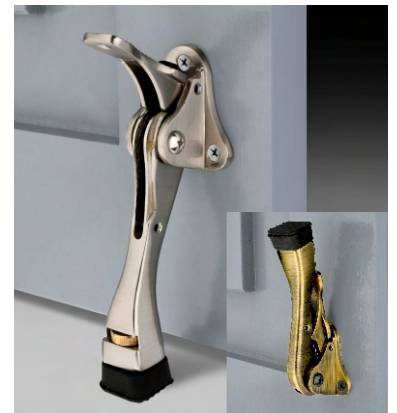

ZS 14 - Magnetic Floor Stopper

Material: Zinc
Finish: NS / AB / BM
Description: Door Stopper

Packing/Box	MRP/Pc
10 Pc.	255/-





Locks & Hardware

DOOR STOPPERS

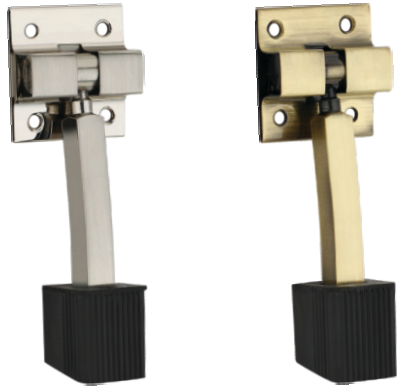

SS 01 - Single Leg

Material: Stainless Steel
Finish: AB / NS / AM
Description: Door Stopper

Size	Packing/Box	MRP/Pc	
		NS	AB/AM
125mm	8 Pc.	124/-	156/-

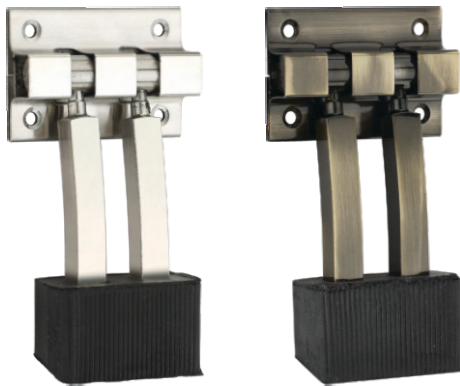

SS 02 - Double Leg

Material: Stainless Steel
Finish: AB / NS / AM
Description: Door Stopper

Size	Packing/Box	MRP/Pc	
		NS	AB/AM
125mm	6 Pc.	185/-	225/-

DOOR EYE



BRDV 01 Round Door Eye

Material: Brass
Finish: AB / BM / PVD Gold
Description: Door Stopper

Packing/Box	MRP/Pc	
	AB/BM	PVD GOLD
12 Pc.	320/-	380/-



NUMARICS



SNU - 01 Numarics

Material: Stainless Steel
Finish: AB
Description: Numarics

Size	Packing/Box	SS	MRP/Pc	
			AB	PVD FG/RG
75mm	1 Pc.	118/-	140/-	160/-





Locks & Hardware

BRASS TOWER BOLT



BTB 01 - ROUND CUT

Material: Brass

Finish: AB, TTAB, BGC, PVD RG, PVD FG

Size	Packing Box	MRP/Pc		
		AB	TTAB/BGC	PVD RG/FG
10x100mm / 4"	10 Pc.	449/-	455/-	583/-
10x150mm / 6"	10 Pc.	673/-	683/-	875/-
10x200mm / 8"	10 Pc.	897/-	911/-	1166/-
10x250mm / 10"	5 Pc.	1121/-	1139/-	1457/-
10x300mm / 12"	5 Pc.	1345/-	1366/-	1749/-
10x450mm / 18"	5 Pc.	2039/-	2071/-	2650/-
10x600mm / 24"	5 Pc.	2747/-	2790/-	3571/-

ALUMINIUM TOWER BOLT



ALTB 402 (12mm)

Material: Aluminium

Finish: SS / AB

Size	Packing/Box	MRP/Pc
100mm / 4"	10 Pc.	191/-
150mm / 6"	10 Pc.	287/-
200mm / 8"	10 Pc.	282/-
250mm / 10"	5 Pc.	478/-
300mm / 12"	5 Pc.	573/-
450mm / 18"	5 Pc.	860/-
600mm / 24"	5 Pc.	1147/-

ALTB 301 (10mm)

Material: Aluminium

Finish: SS / AB

Size	Packing/Box	MRP/Pc
100mm / 4"	10 Pc.	170/-
150mm / 6"	10 Pc.	255/-
200mm / 8"	10 Pc.	340/-
250mm / 10"	5 Pc.	425/-
300mm / 12"	5 Pc.	538/-
450mm / 18"	5 Pc.	807/-
600mm / 24"	5 Pc.	1076/-





Locks & Hardware

ALUMINIUM TOWER BOLT

ALTB 1001 (10mm)

Material: Aluminium
Finish: SS / AB
Description: Tower Bolt SS Rod

Size	Packing/Box	MRP/Pc
75mm / 3"	12 Pc.	85/-
100mm / 4"	12 Pc.	114/-
150mm / 6"	12 Pc.	170/-
200mm / 8"	12 Pc.	227/-

ALTB 1002 (12mm)

Material: Aluminium
Finish: SS / AB
Description: Tower Bolt SS Rod

Size	Packing/Box	MRP/Pc
100mm / 4"	10 Pc.	156/-
150mm / 6"	10 Pc.	234/-
200mm / 8"	10 Pc.	312/-
250mm / 10"	5 Pc.	390/-
300mm / 12"	5 Pc.	468/-



STAINLESS STEEL TOWER BOLT



SLTB 1001 (10mm)

Material: Stainless Steel
Finish: SS

Size	Packing/Box	MRP/Pc
75mm / 3"	12 Pc.	59/-
100mm / 4"	12 Pc.	79/-
150mm / 6"	12 Pc.	119/-



SLTB 1002 (12mm)

Material: Stainless Steel
Finish: SS/AB
Description: Jointless

Size	Packing/Box	MRP/Pc	
		SS	AB
150mm / 6"	10 Pc.	350/-	414/-
200mm / 8"	10 Pc.	467/-	552/-
300mm / 12"	10 Pc.	701/-	828/-
450mm / 18"	5 Pc.	1051/-	1243/-
600mm / 24"	5 Pc.	1402/-	1657/-





Locks & Hardware

DOOR LATCHES

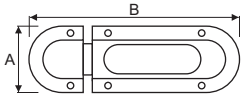

ZLBL 01 - Latch

Material: Zinc
 Finish: SS/AB/RG/BM
 Description:
 Bathroom Latch Tower Bolt

Size	Packing/Box	MRP/Pc	
		AB/SS	RG/BL
100mm / 4"	10 Pc.	415/-	440/-



SLBL 02 - Latch

Material: Stainless Steel
 Finish: SS / AB
 Description:
 Bathroom Latch Tower Bolt

Size	Packing/Box	MRP / Pc.	
		SS	AB
100mm / 4"	8 Pc.	280/-	330/-



ALBL 01 - Latch

Material: Aluminium
 Finish: SS / AB
 Description:
 Bathroom Latch Tower Bolt

Size	Packing/Box	MRP / Pc.	
		NS / AB	
100mm / 4"	8 Pc.	255/-	





Locks & Hardware

ALUMINIUM PC TOWER BOLT



ALTB/SR - Knockout Hex

Material: Alu. / Iron Rod
Finish: Power Coated
Description: Alu. Body Iron Rod Tower Bolt

Size	Packing Box	Packing Carton	MRP / DZ
12 x 100mm	12 Pcs.	56 Box.	519/-
12 x 150mm	12 Pcs.	42 Box	716/-
12 x 200mm	12 Pcs.	30 Box	913/-



ALTB/SR - 903 Hex

Material: Alu. / Iron Rod
Finish: Power Coated
Description: Alu. Body Iron Rod Tower Bolt

Size	Packing Box	Packing Carton	MRP / DZ
12 x 100mm	12 Pcs.	56 Box.	680/-
12 x 150mm	12 Pcs.	42 Box.	930/-
12 x 200mm	12 Pcs.	30 Box	1185/-



ALTB/SR - 901 Round

Material: Alu. / Iron Rod
Finish: Power Coated
Description: Alu. Body Iron Rod Tower Bolt

Size	Packing Box	Packing Carton	MRP / DZ
12 x 100mm	24 Pcs.	56 Box.	600/-
12 x 150mm	12 Pcs.	42 Box.	825/-
12 x 200mm	12 Pcs.	30 Box	1056/-



ALTB/SR - 702 Hex

Material: Alu. / Iron Rod
Finish: Power Coated
Description: Alu. Body Iron Rod Tower Bolt

Size	Packing Box	Packing Carton	MRP / DZ
9 x 75mm	24 Pcs.	57 Box	340/-
9 x 100mm	12 Pcs.	76 Box	430/-



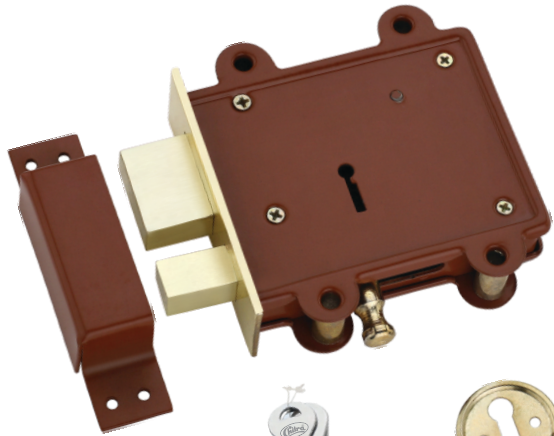

DKB 01

Finish: Power Coated

Description: Lever Lock with 3 CP Keys Iron Latch (2 in 1)

Function	Packing/Box	MRP/Pc
6 Levers	1 Pc.	520/-

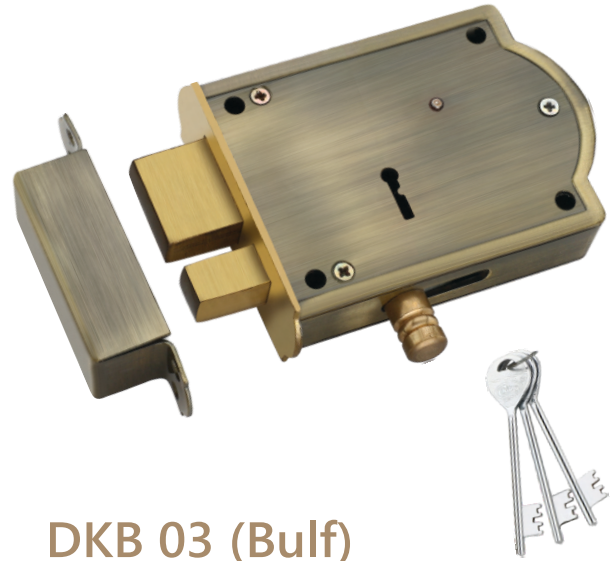
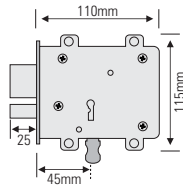

DKB 03 (Bulf)

Finish: AB

Description: Lever Lock with 3 CP Keys Brass Latch (2 in 1)

Size	Packing/Box	MRP/Pc
150mm	1 Pc.	1060/-

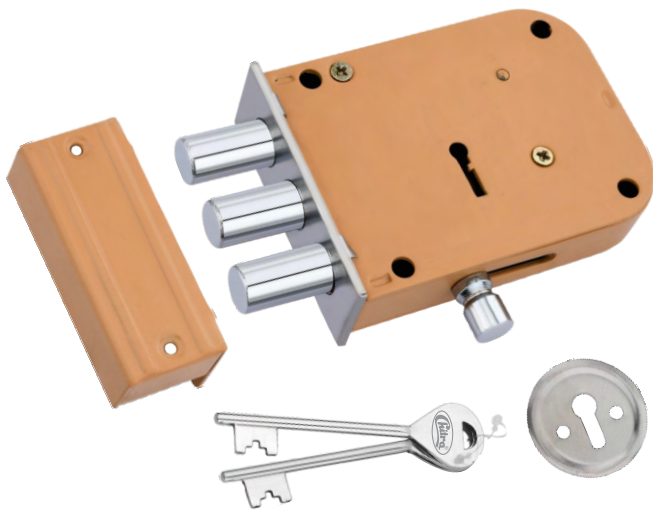
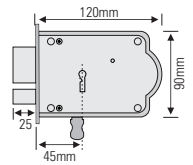

DKB 04 (3 Bullet)

Finish: Power Coated

Description: Lever Lock with 2 CP Keys Iron Bullets (2 in 1) 3 Bullets

Size	Packing/Box	MRP/Pc
100mm	1 Pc.	530/-

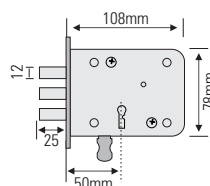

LB 01 Locking Bolt

Finish: Power Coated

Description: Locking Bolt 6 Lever Lock with 3 Keys

Size	Packing/Box	MRP/Pc
200mm/8"	1 Pc.	650/-
275mm/11"	1 Pc.	710/-

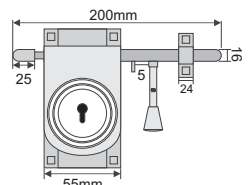



Locks & Hardware

CUPBOARD LOCKS



CBO - 05

Finish: CP

Description: Multipurpose Lock 11 Pin Reversible Keys

Size	Packing/Box	MRP/PC	
		SS	AB/RG/BM
25mm	10 Pc.	600/-	635/-
30mm	10 Pc.	635/-	670/-

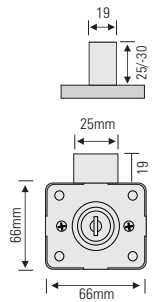

Brass Latch



14 Pin Brass Cylinder

CBO 01

Finish: SS

Description: Cupboard Lock Ultra Hi-tech 14 Pin CY with 2 Brass Ultra Keys

Size	Packing/Box	MRP/Pc
23/25mm	10 Pc.	590/-
29/32mm	10 Pc.	645/-

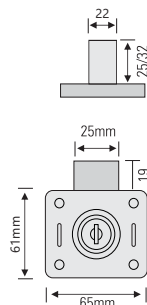

Brass Latch



11 Pin Brass Cylinder

CBO 02

Finish: Black

Description: Cupboard Sliding Lock Ultra Hi-tech 14 Pin CY with 2 Brass Ultra Keys

Size	Packing/Box	MRP/Pc
25mm	10 Pc.	610/-
32mm	10 Pc.	660/-

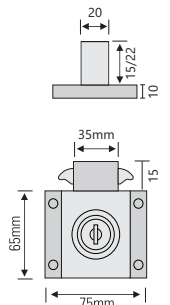



ML 222

Finish: Black

Description: Multipurpose Lock 6 Brass Lever
Rubber Coated Keys

Size	Packing/Box	MRP/Pc
23mm	10 Pc.	124/-

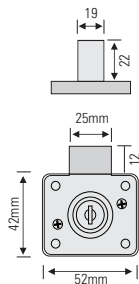

ML 333

Finish: CP

Description: Multipurpose Lock 7 Lever
Rubber Coated Reversible Keys

Size	Packing/Box	MRP/Pc
23mm	10 Pc.	135/-

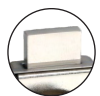
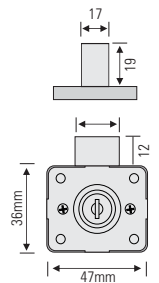

Brass Latch



8 Pin Brass Cylinder



Brass Ultra Keys

ML 02 Ultra

Finish: SS

Description: Ultra Hi-tech 8 Pin CY with
2 Brass Ultra Keys

Size	Packing/Box	MRP/Pc
23mm	10 Pc.	400/-

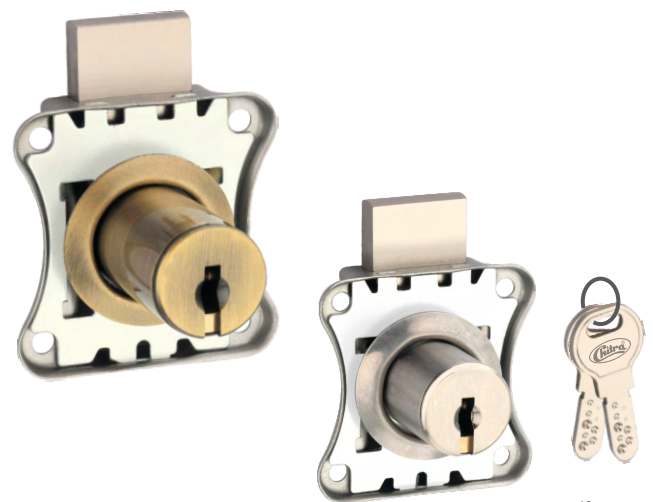
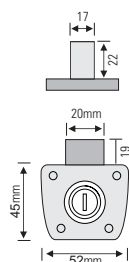

ML - 03

Finish: SS/AB

Description: Multipurpose Lock 11 Pin
Reversible Keys

Size	Packing/Box	MRP/PC	
		SS	AB
20mm	10 Pc.	425/-	460/-
25mm	10 Pc.	460/-	495/-

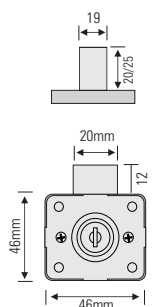



Locks & Hardware

HANGER

Stainless Steel



SS



Antique



BM



Curve

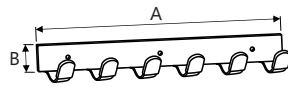

Finish: SS / ABM / BM

Description: Stainless Steel Hanger

Legs	A (in mm)	B (in mm)	Packing/ Box	MRP /Pc
4	190	27	10 Pc.	235/-
6	290	27	20 Pc.	355/-
8	390	27	20 Pc.	470/-

TOWEL HOLDER

Stainless Steel



Antique



SS



BM

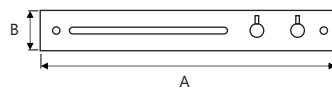
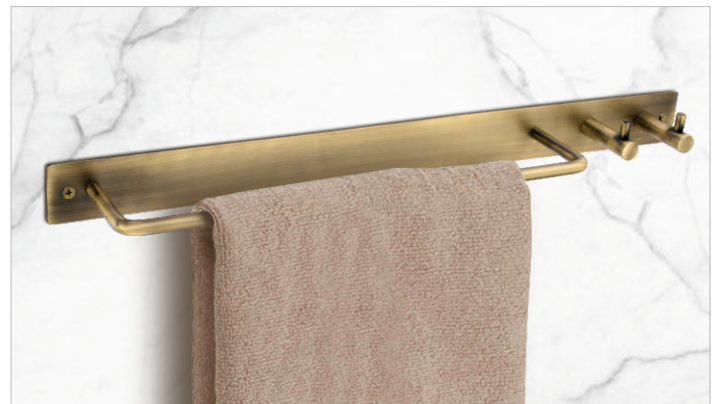

Towel Holder T01

Finish: SS / ABM / BM

Description: Stainless Steel Towel Holder

Legs	A (in mm)	B (in mm)	Packing/ Box	MRP / Pc	
				SS	ABM / BM
2	400	34	10 Pc.	660/-	800/-



An ISO 9001 : 2015 Certified Co.



An ISO 9001 : 2015 Certified Co.

CHITRA ENTERPRISES

Aligarh - 202001 (U.P.) INDIA

🌐 www.metcraftchitra.com

✉ enterprises.chitra@gmail.com

f www.facebook.com/chitalocks

👤 +91 89233 52234

🐦 www.twitter.com/chitalocks



Scan QR code
to get more information



Indian Origin



Global
Leadership



66+ Years of
Experience



Worldwide
Presence



International
Warranty



ISO 9001:2015
Certified

www.metcraftchitra.com