



SS 304 PVD PROFILES

**304
GRADE**



About Us

We have been meeting the diverse needs of our clients since our establishment in 1966. We have introduced various products to the Indian market, raising standards while maintaining economies. We are proud to be a recognizable and dependable name in the industry, with over 500 satisfied dealers and several OEM clients. Our brands SH, ARJUN, and ITC have set benchmarks in quality in their respective fields.

Organizational Philosophy





Quality is never an accident, it is always the result of positive intention, sincere effort, skilful execution and wise choice among many available alternatives. Our team of qualified professionals, technicians and workers, dedicatedly put hard efforts to continuously raise the bar for the quality of all our products and Services Quality is the cornerstone of our success.

Our Team

Our team of talented professionals delivers uncompromised quality products. Our marketing team listens to customer feedback to stay updated on market trends. Our R&D team works to keep our business competitive and innovative. We offer a wide range of industrial fasteners for various industries, including building and construction, DIY, automobile, and agriculture.

All Profiles are available in 10 feet length

T - Profiles

SIZE	QTY in 1 Box	PRICE	FINISHES
T-6mm	100	1000	 Rose Gold  Gold  Black  Chrome Polish
T-8mm	100	1100	
T-10mm	100	1150	
T-12mm	80	1200	
T-15mm	50	1300	
T-20mm	40	1475	
T-25mm	30	1650	
T-32mm	30	2250	

U - Profiles

SIZE (mm)	QTY in 1 Box	PRICE	FINISHES
U-12x12x12	50	1200	 Rose Gold  Gold  Black
U-12x20x12	50	1275	
U-12x25x12	50	1375	

STRIP (FLAT)

SIZE	QTY in 1 Box	PRICE	FINISHES
FLAT 8mm	-	360	 Rose Gold  Gold  Chrome Polish  Black
FLAT 12mm	-	450	
FLAT 20mm	100	600	
FLAT 25mm	100	700	
FLAT 37mm	50	975	

L - Profiles

SIZE (mm)	QTY in 1 Box	PRICE	FINISHES
L - 12x12	100	1000	 Rose Gold  Gold  Chrome Polish
L - 20x20	-	1175	
L - 25x25	50	1400	

T-Profiles



Technical Specifications

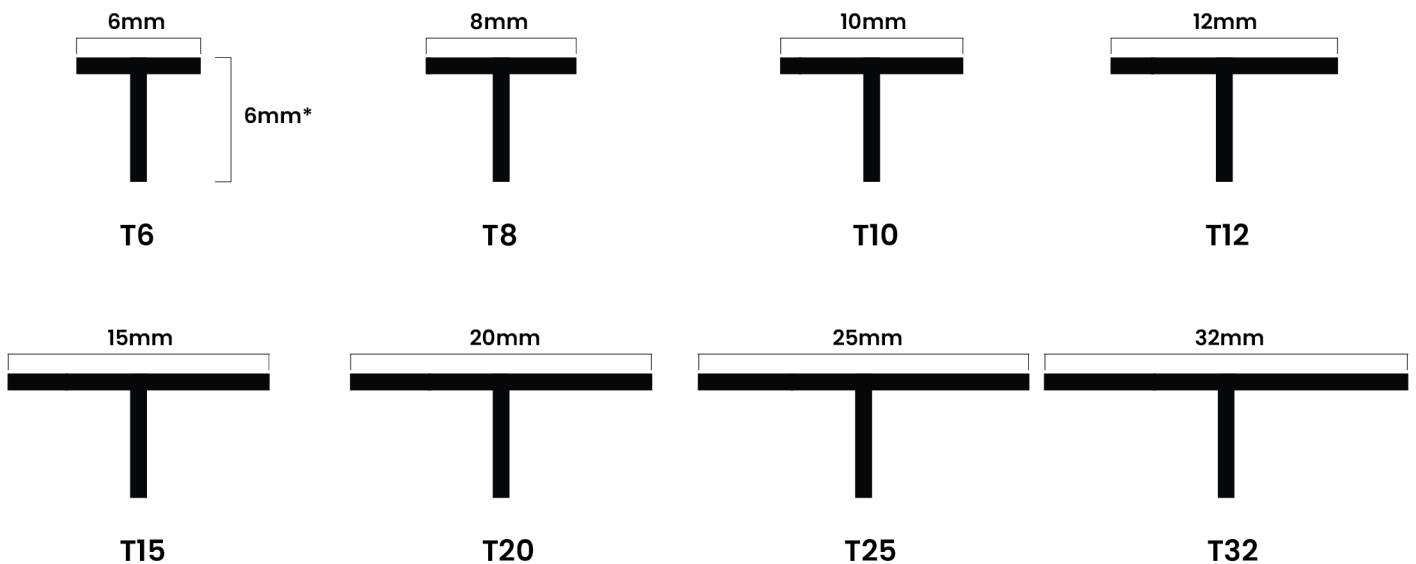

*The dimension of 6mm shall remain constant across all variations of this profile.

SH[®]

SS 304 PVD PROFILES

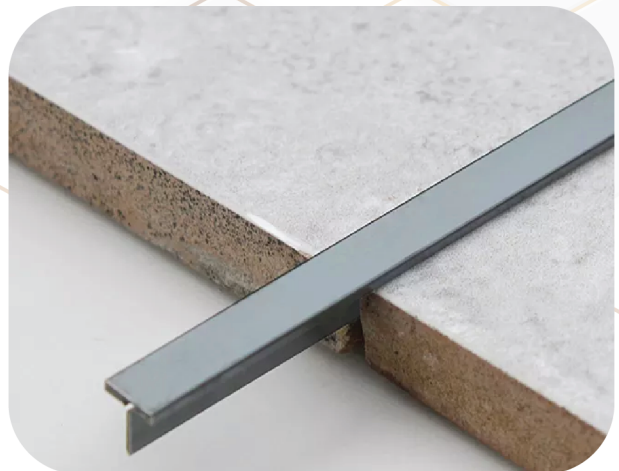

U-Profiles



Technical Specifications

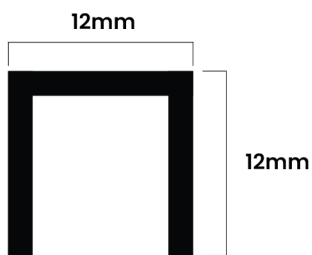

U12

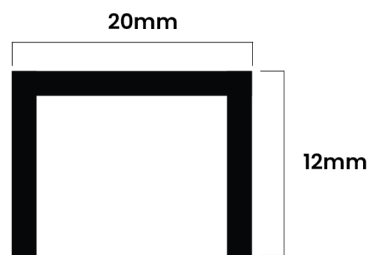

U20

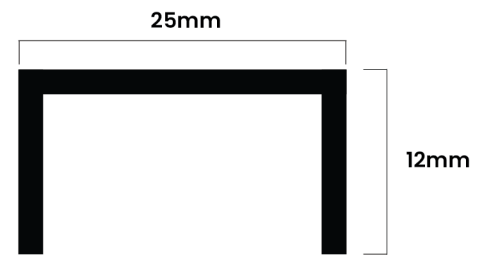

U25

SH[®]

SS 304 PVD PROFILES

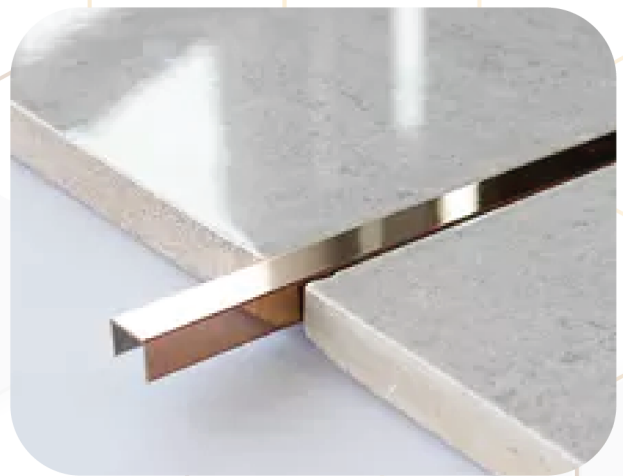

STRIP



Technical Specifications

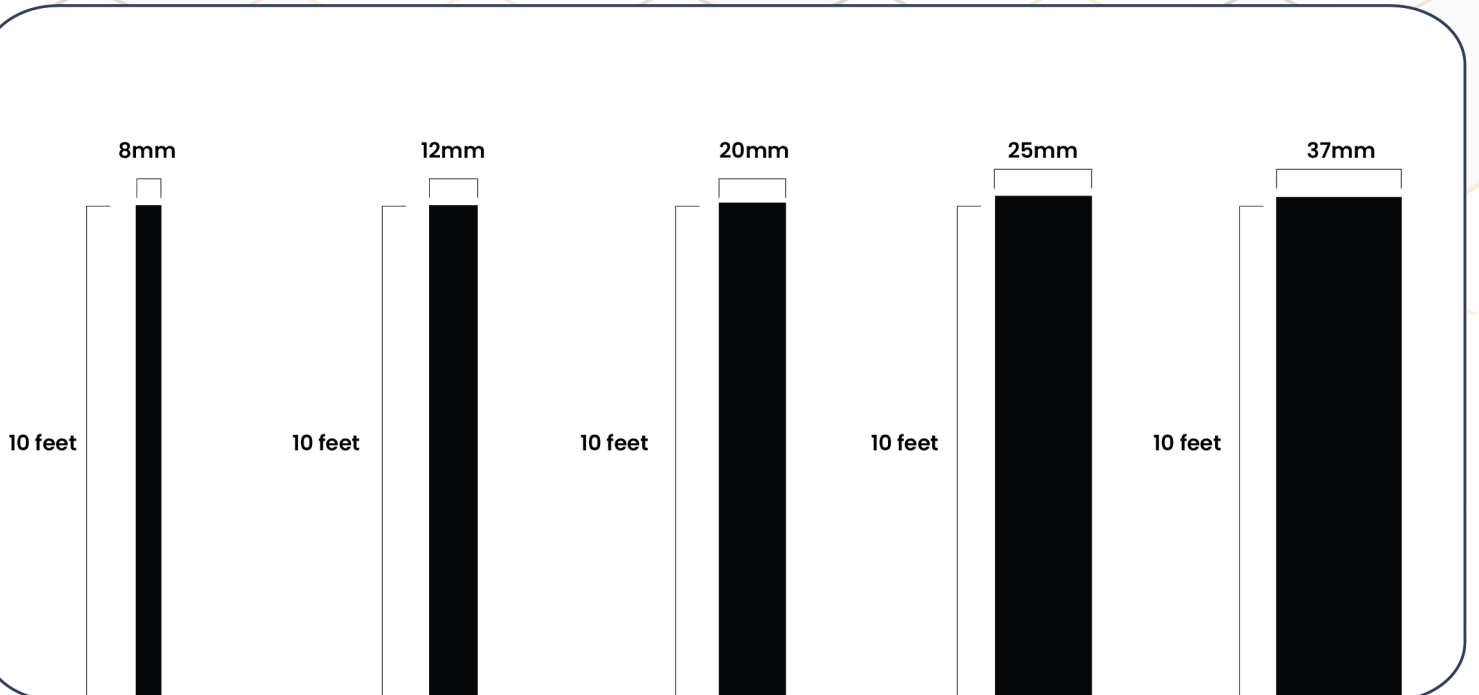

SH[®]

SS 304 PVD PROFILES





L-Profile

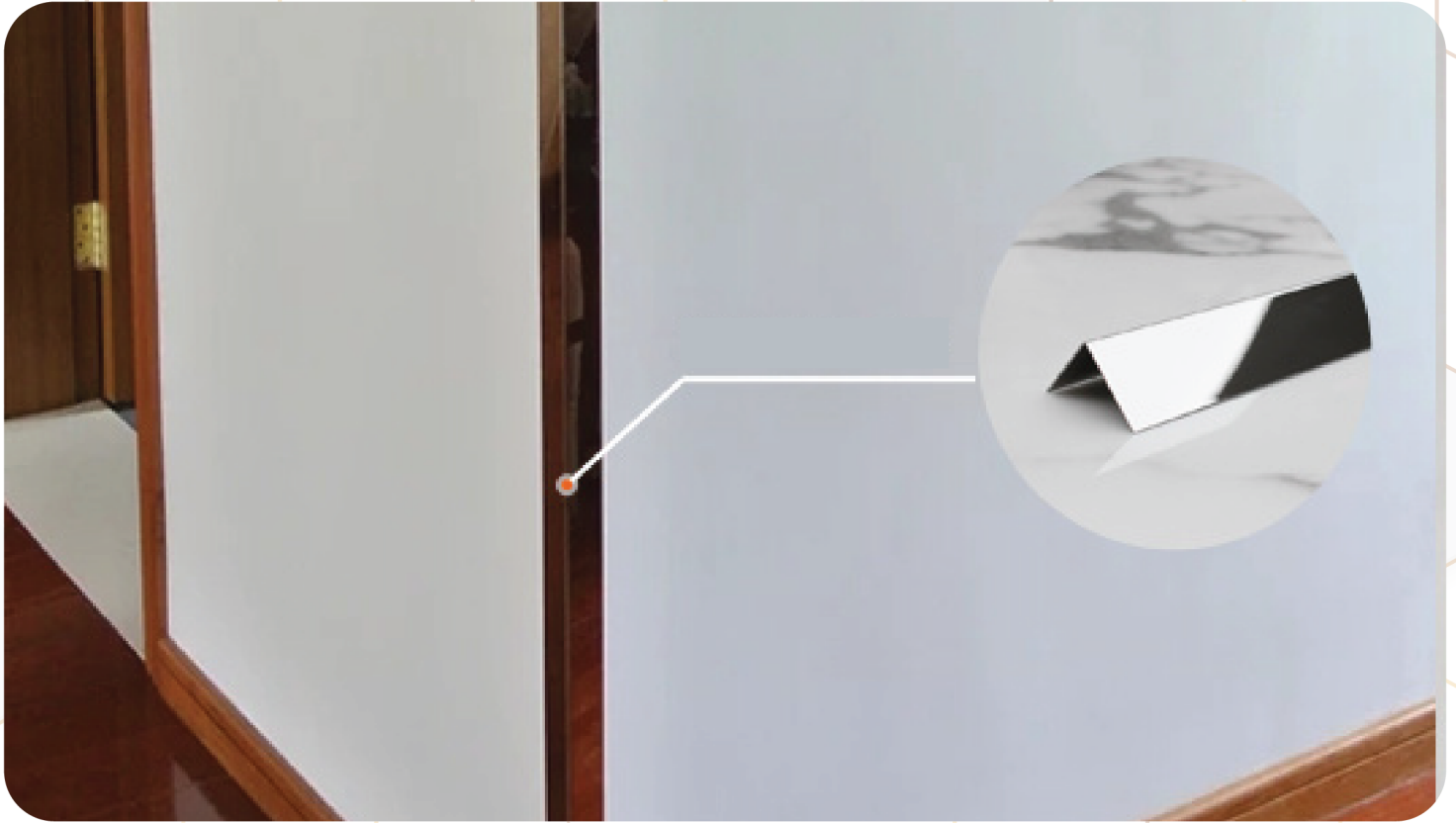

Technical Specifications

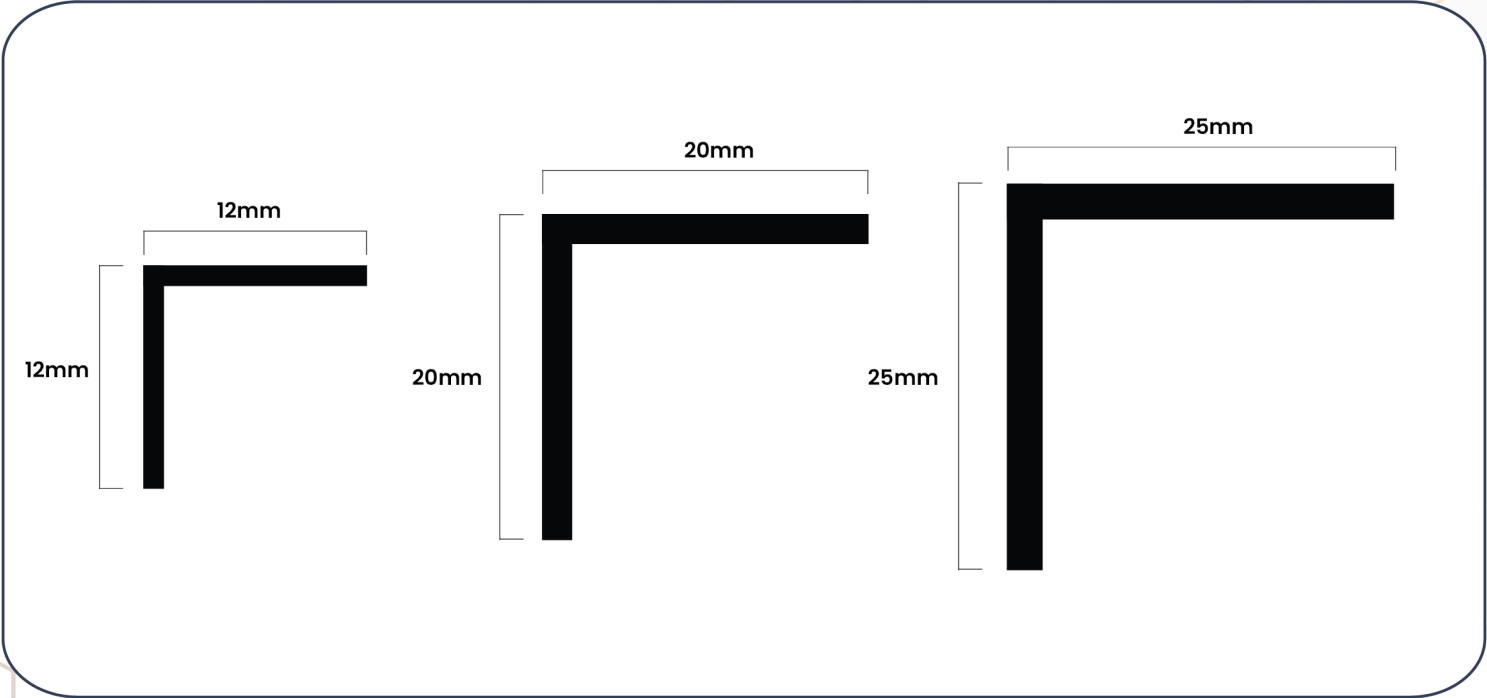

SH[®]

SS 304 PVD PROFILES



